This is a reproduction of a library book that was digitized by Google as part of an ongoing effort to preserve the information in books and make it universally accessible.

Google™ books

<https://books.google.com>



FORESTRY

SD

533

U58

1935

BUHR A



a39015

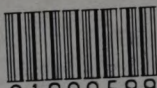

01800589



5b

INSTRUCTIONS

FOR THE

SCALING AND MEASUREMENT OF NATIONAL-FOREST TIMBER

Issued September 23, 1916
Revised October 1935

U. S. DEPARTMENT OF AGRICULTURE
FOREST SERVICE
F. A. SILCOX, Chief

Forestry

S.D.

533

. 1158

1735

INSTRUCTIONS
FOR THE
SCALING AND MEASUREMENT
OF NATIONAL-FOREST
TIMBER

JUN 1 1936



UNITED STATES
GOVERNMENT PRINTING OFFICE
WASHINGTON : 1935

For sale by the Superintendent of Documents, Washington, D. C. - Price 15 cents (paper cover)

Forestry

SD

533

.2658

1935



Foresty kit
6-2-36
=

CONTENTS

	Page
The scaling and measurement of national-forest timber	1
Regulation on scaling	1
Customary commercial units used	2
Scaling logs	2
Policy	2
Scale of timber in the log	2
Use of mill checks	2
Defects to be considered in scaling	3
Mill overrun	4
Assurances to purchasers	5
Definition of merchantable logs	5
Designation of places for scaling	6
Frequency of scaling	6
Requirements of purchasers	6
The log rule	7
Log lengths	7
Allowances for trimming	8
Measuring, numbering, and stamping logs	9
Measuring log lengths	9
Measuring diameters	9
Numbering logs	9
Scale-book letters	10
End check on logs	11
Stamping logs	11
Check on total number of logs	12
Deductions for defects	12
Standard rule	12
Diagrams of common defects	14
Rules of thumb	15
Right cylinder	15
Average diameter of logs	16
Center or circular rot	16
Ground or stump rot	18
Other fungous rots	19
Cat face or fire scar	20
Shake or pitch ring	20
Heart check, pitch seam, or split	22
Lightning defect	22
Crook or sweep	23
Wind or sun check	24
Blue stain	25
Crotch	25
Wormholes	26
Determining the merchantability of logs	26
Scaling green and dead timber	26
Penalty scale	27
Scaling length	27
Settlement of complaints	28
Check scaling	28
Mill-scale studies	29

A 6-15-36 711410

	Page
Scaling from the stump.....	30
Use of stump scales.....	30
In timber trespass.....	30
*Tree measurement instead of log scale.....	31
*Cubic measurements.....	31
Policy.....	31
Merchantable timber.....	32
Requirements of purchasers.....	32
Check measurements.....	32
Cord measure.....	32
Policy.....	32
Cord measurements.....	33
Stamping and numbering.....	33
Cubic-foot measure.....	33
Policy.....	33
Measurements.....	34
Deductions for defect.....	34
Linear measurements.....	35
Policy.....	35
Merchantable timber.....	35
Requirements of purchasers.....	35
Measurement.....	35
Board-foot equivalents.....	36
Stamping and numbering.....	36
Check measurements.....	36
Combined linear and diameter measurements.....	36
Counting.....	37
Policy.....	37
Merchantable timber.....	37
Requirements of purchasers.....	37
Stamping and numbering.....	37
Check measurements.....	37
Weighing.....	38
Records and reports.....	38
Scale books.....	38
Penalty-scale records.....	40
Check of scale books.....	40
Cutting reports.....	40
Penalty-scale reports.....	41
Check and record of cutting reports.....	42
Scale records for purchasers.....	42
Report of timber cut and sold.....	42
Regional forester's quarterly report.....	43
Report on miscellaneous products.....	43
Appendix.....	44
Table 1.—Scribner decimal C log rule.....	44
Table 2.—Deduction for rectangular defects.....	52
Table 3.—Deduction for squared defects.....	70
Table 4.—Solid cubic contents of logs.....	73
Table 5.—Board-foot contents of standard sizes of timber.....	76
Table 6.—Standard converting factors.....	79
Table 7.—Converting factors—chestnut telephone poles.....	80
Table 8.—Areas of circles.....	80
Table 9.—Taper.....	81
Table 10.—Taper.....	82
Sample page 1, Form 231, saw timber.....	84
Sample page 2, Form 235, saw timber.....	86
Sample page 3, Form 651, saw timber.....	88

CONTENTS

v

Appendix—Continued.	Page
Sample page 4, Form 651, saw timber, summary sheet.....	90
Sample page 5, Form 285, cubic feet.....	92
Sample page 6, Form 648, cord measurement.....	94
Sample page 7, Form 285, poles and piling.....	96
Sample page 8, Form 648, props, ties, and posts.....	98
Sample page 9, Form 648, railroad ties.....	100
Log-scaling and grading rules of the Puget Sound Log Scaling and Grading Bureau.....	102
Douglas-fir logs.....	102
Gray fir.....	102
Cull logs.....	102
Log-scaling and grading rules of the Columbia River Log Scaling and Grading Bureau.....	102
Douglas-fir logs.....	102
Cull logs.....	103
Western yellow pine log-grading, rules suggested by the Forest Service, for use in eastern Oregon and Washington.....	103

THE SCALING AND MEASUREMENT OF NATIONAL-FOREST TIMBER

The following instructions govern the scaling and measurement of national-forest timber. They supplement the National Forest Manual and will be followed in the administration of timber sales, timber settlements, timber trespass, free use, and administrative use. Uniform standards and methods are necessary in all national-forest work involving the measurement of timber. It is therefore essential that these instructions be carried out strictly by all forest officers.

Unless timber is sold on an estimate in the tree, it must be scaled, counted, or measured before it is removed from the cutting area or from the place designated for scaling.

Regulation on Scaling.

The regulation of the Secretary of Agriculture on scaling national-forest timber is as follows:

Reg. S-16. No live tree shall be cut under any timber-sale contract until marked or otherwise designated for cutting by a forest officer.

The volume of national-forest timber in a sale may be determined by scaling, measuring, or counting the logs or other products, or by measuring the trees before cutting. If the contract provides for the determination of volume by tree measurement and the timber has been paid for, the stamping of the tree authorizes cutting and removal. Otherwise no timber cut under any contract shall be removed from the place designated until it has been scaled, measured, or counted, and stamped by a forest officer, unless such removal is specifically authorized in the agreement.

No person except a forest officer shall stamp any timber belonging to the United States upon a national forest with the official marking ax or any instrument having a similar design.

The cubic volume rules and the Scribner decimal C log rule, both as used by the Forest Service, are the official rules for scaling national-forest timber.

Customary Commercial Units Used.

National-forest timber is appraised, sold, and measured by the customary commercial units for the product involved. As a standard practice, saw timber will be scaled by the thousand feet log scale, railroad ties by the piece of stated minimum size, mining timbers by the piece or linear foot, telephone poles by the linear foot or by the piece of stated length, piling by the linear foot, pulpwood by the solid cubic foot or cord, and fuel wood, shingle bolts, and similar material by the cord. Other units may be used when better adapted to local trade customs.

SCALING LOGS

POLICY

Scale of Timber in the Log.

Scaling, as practiced by the Forest Service, is the measurement of sound material in the log and relates to quantity rather than quality of material. Timber will therefore be scaled in accordance with the defect in the log and not in relation to any particular grades of lumber it will produce.

Scaling sound contents in the log rather than material of certain lumber grades is the standard practice of the service for the following reasons:

(1) The unit of measure is regarded as more stable, with less fluctuation from year to year, than where lumber grades are followed. Greater certainty is thus assured purchasers as to what material they will be required to pay for throughout the life of their contracts.

(2) The basis of scaling is less subject to individual judgment. It is more readily learned by scalers and more uniformly applied, and hence is more practicable as a common standard for a large number of scalers in timber of varying size and quality.

(3) Mill tallies are not required for effective application of the scale or to settle complaints by purchasers. The obligation to check the scale by mill studies, which is implied in scaling to certain lumber grades is avoided. The accuracy of the scale is directly and inexpensively determined by a check on the logs themselves.

Use of Mill Checks.

At the same time, proficient scaling requires a knowledge of how timber "cuts out." The best way to train the judgment and instruct scalers in making deductions for particular kinds of defect is to see how defective logs open up in the mill and the

actual loss as compared with sound logs of the same size. The check made by a scaler at the mill should be on the amount of defect shown in the lumber as against his estimated allowance for defect, and should not be based on the mill tally of lumber. Frequent mill checks are therefore desirable, not to correct the previous scale, but to train the scaler's judgment in making allowance for various classes of defect.

In training and instructing scalers, in check scaling, settling complaints, and discussing proposed sales, and in other matters of scaling practice, scaling to include certain grades of lumber and exclude other grades will be avoided as far as practicable.

Defects to be Considered in Scaling.

Log defects include rot or any defective or waste material, crooks, or other features which actually reduce the yield of lumber from the log. The most common forms of unsound defects which affect the yield of lumber are rot, shake, check, pitch ring, cat face, and wormholes. Two other and less common, forms of defect which affect the yield of lumber and for which deductions may be authorized by the regional forester, according to the actual local merchantability of the material are: (1) Massed black or red pitch, commonly found in badly fire-scarred butt logs of western yellow pine; and (2) large knots so clustered or so close together in top logs that they affect the logs as merchantable products. Ordinarily, sound knots slightly pitched butts, and discoloration affect the quality and not the yield of lumber produced and will not be recognized as defects in scaling.

In Forest Service scaling, deductions will not be made for defects outside of the right cylinder (a cylinder whose sides are at right angles to the top and base; see Fig. 2) represented by the top end and total length of the log, or for defects in the portion of the log which will be slabbed off. Material secured outside the cylinder is part of the overrun and is taken into account together with overrun from other sources in fixing the price of the timber. For this reason overrun should not affect the scale in any manner or influence the scaler in making deductions.

Otherwise deductions will be made for all visible defects which will actually reduce the yield of lumber from the log. There must, however, be an unmistakable surface indication of the defect. The scale should never be reduced simply because the timber is known to be more or less defective, or because hidden defect frequently appears in sawing.

In applying the foregoing the loss will be those portions of the boards from the cylinder which must be trimmed off because of the defect, provided that the remainder of each board has at least the minimum length manufactured from the species in standard milling practice in the region and is at least 4 inches wide. If the remainder of any board is shorter or narrower than these limits, the entire board will be considered lost.

The methods of manufacture of particular purchasers will not be taken into account by scalers. No attempt should be made to adjust the scale to losses due to poor equipment, inefficient methods, the sawing of extra thicknesses, or to catch up gains from exceptionally close utilization. It is the scaler's function to determine the amount of sound material in the log as uniformly as possible, whatever the mill tally may be.

Mill Overrun.

In making mill checks or more extensive "mill studies," it is of course desirable to compare the total cut of all merchantable grades of lumber with the log scale under the standard Forest Service method, thus determining the overrun.

Mill overrun is made up of—

(1) Any saving in saw kerf under one-fourth inch, the kerf upon which the scale rule is based.

(2) The saving in kerf from cutting dimension stock, timbers, and other material over an inch thick.

(3) Trade practice in cutting lumber of scant thickness.

(4) Utilization of narrow widths in slabbing, not included in the diagrams upon which the Scribner scale is based.

(5) Utilization of short lengths from the swell of logs, not included in the Scribner diagrams.

(6) Utilization of lumber grades which admit considerable unsound material, rot, broken-down sap, etc., which should be eliminated in the scale.

The first five sources of overrun are obtained from all classes of logs, sound as well as defective. The normal overrun from these sources under the Scribner log scale ranges from 4 to 20 per cent, depending upon the size and taper of the timber. This overrun should be obtained under Forest Service scaling in sound timber. In defective timber it should be obtained in the grades of lumber admitting sound defects—such as sound knots, firm red rot, etc.—for which no deductions are made in the scale.

Since the scale deducts for all unsound defects visible in the log, except those outside of a cylinder represented by the top end and length and those which will be slabbed off in milling, lumber grades containing considerable amounts of such defect,

if such lumber is manufactured, should under accurate scaling be largely overrun. Good scaling under the Forest Service standard should thus yield an overrun equivalent to the greater part of the cut of grades which contain considerable quantities of unsound defect in addition to the normal overrun on sound logs.

Assurances to Purchasers.

No assurances regarding the Forest Service scale should be made to purchasers, except that—

(1) The service will give them a scale of the sound material in the log under the Scribner decimal C rule. The Forest Service practice of reading diameters to the nearest, instead of the next lower, inch should be made clear, together with the requirements governing maximum scaling length, trimming allowance, and penalty for overrunning the trimming allowance.

(2) The Forest Service will make systematic checks on the local scale by more experienced scalers of special competency.

(3) The Forest Service will make special check scales by the best men in its organization in case of serious complaint.

Where mill-scale studies have been made, prospective purchasers may be furnished with the results of the Forest Service scale in given classes of timber as to species, size, soundness, etc., and under specified manufacturing methods. The furnishing of such information should, however, convey no direct or implied guaranty whatsoever on the overrun in a proposed scale.

Assurances to purchasers should be restricted absolutely to those given above. *Never should any assurance or promises be made on amount of overrun.*

Definition of Merchantable Logs.

Every timber-sale agreement should define exactly the material to be classed as merchantable under its terms. Exceptions to this rule may be made only in rangers' sales where satisfactory standards of utilization have been established. In sale of saw logs this definition will consist of—

(1) The minimum length of merchantable logs.

(2) The minimum diameter at small end.

(3) A minimum percentage of the gross scale of the log remaining after deductions for defect. (See merchantability clause, Form 202, Timber Sale Agreement.)

And, where desirable:

(4) The minimum length and width of material in any log which will be considered merchantable.

Percentages under No. 3 have been established for each species in each region and will ordinarily be applied uniformly in saw-log sales. These percentages will be not more than 33½ per cent of the gross scale of logs of the more valuable commercial species and not more than 50 per cent of the gross scale of logs of inferior species.

As soon as the necessary data are obtained from mill studies or through other investigations, the standard definition of merchantable logs may include a specific statement of the treatment in Forest Service scaling of common defects or alleged defects in the timber of the region. This makes the work of different scalers more uniform and the Forest Service standard more stable. For instance, it is now standard practice in region 1 to indicate in sale agreements that no deductions will be made for firm red stain and firm blue stain in Idaho white pine, which mill studies have shown convincingly do not affect the cut of sound lumber.

Designation of Places for Scaling.

Unless specified in the sale agreement, the places where timber is to be scaled will be designated by the officer in charge of the sale. Such places should be adapted, as far as reasonable economy in scaling will permit, to the practical requirements and methods of operation, so as to impose as little additional cost upon the operator as possible. Scaling will not be done, however, in places or under conditions dangerous to life or limb.

Frequency of Scaling.

In small sales the frequency of scaling must be adapted to the reasonable requirements of the purchaser. It is desirable to scale only at intervals within which considerable quantities of timber are logged and assembled, such as 15,000 or 20,000 feet. Any such measures to promote economy must, however, be enforced only as far as it is practicable for the purchaser to comply with them.

In larger sales the most economical plan of scaling should be considered in advance and provided for in the sale agreement. (See standard clauses 40 to 47, inclusive p. 49-S, National Forest Manual.)

Requirements of Purchasers.

The bunching or skidding of logs is usually unnecessary for efficient or economical scaling. Where necessary, however, for this purpose, purchasers may be required to assemble and hold logs for scaling in the manner prescribed by the forest officer.

This should be covered by a specific clause in the sale agreement. On the other hand, methods of scaling should, so far as practicable, be adapted to the operating methods of the purchaser.

If cutting is to be done on Government and private lands simultaneously, the purchaser should be required to keep the logs separate up to the point of scaling.

The Log Rule.

All saw timber will be scaled by the Scribner decimal C log rule or measured by the cubic foot. The Scribner decimal C log rule drops the units and gives the contents of a log to the nearest 10 board feet. One cipher added to the sum of the numbers read from the scale stick gives the total scale of the log, except in the case of 6-inch logs, 6, 7, 8, and 9 feet long and 7-inch logs 6 feet long. The reading for these is 0.5, which multiplied by 10 gives 5 feet as the actual scale.

Scale sticks for logs of even lengths are furnished in 30, 36, 48, 60, and 72-inch lengths.

In the absence of a scale stick, or where the position of logs in the pile makes its use difficult, their diameters and lengths may be measured and the scale figured from a table later, fair allowance being made for defect.

Table 1 of the appendix gives the contents of logs of both odd and even lengths of 6 to 40 feet and of diameters of 6 to 120 inches. One cipher must be added as with the scale stick.

Log Lengths.

In scaling national-forest timber, logs over 16 feet in length will be scaled as two or more logs, as far as practicable, in lengths of not less than 12 feet, except in the following instances:

(a) On the national forests in Alaska and west of the summit of the Cascade Mountains in Washington and Oregon the scaling lengths will be determined in accordance with the instructions given below.

(b) On the Black Hills National Forest 17 and 18 foot mining timbers will be scaled as one log.

(c) On national forests in regions where it is the practice to manufacture railroad ties $8\frac{1}{2}$ feet long, logs of species cut primarily for ties will be scaled as one log if 17 feet long.

Logs exceeding the maximum scaling length will be divided into two or more logs, all as nearly of the same length as is practicable. If a log must be divided into unequal lengths, the butt log should be the longer. Inexperienced men should determine the diameters of the logs into which the long log will be divided, with the exception of the top log, by measuring the

diameter of the long log at both ends and assuming an even taper; but this is not applicable where the log to be divided is a butt log, since taper is not uniform near the butt. Taper tables applicable to the species and region are valuable for training and checking scalers.

For example, a 44-foot log 16 inches in diameter would be scaled as—

One 12-foot log with a diameter of 16 inches.

One 16-foot log with a diameter of 17 inches.

One 16-foot log with a diameter of 19 inches.

Judgment which permits accurate determination of taper without measurement comes only as a result of familiarity with the form of different species in the given region. Especial consideration will always have to be given to the log of abnormal form, since the object is to scale on the basis of the actual taper.

Tables 9 and 10 of the appendix are to be used simply as a guide, the allowance for taper being varied to conform to the actual taper.

On the national forests in Alaska, and west of the summit of the Cascade Mountains in Washington and Oregon, logs up to and including 40 feet in length will be scaled as one log; lengths from 40 to 80 feet, inclusive, will be scaled as two logs as nearly equal in length as possible in even feet. Greater lengths than 80 feet will be scaled as three logs, the division being made as nearly as possible in even feet and the diameter being increased according to the taper of the log. This departure from the usual method does not apply to sales involving chiefly timber which will be marketed in competition with timber of the same species from sales outside this region, such as sales of western yellow pine in southwestern Oregon.

When logs are scaled as two or more logs, the scale allowed for the separate lengths will be added and the total recorded as one log.

The tables for the scale of logs cut in odd lengths, such as 15-foot or 17-foot tie logs, are given on page 44. The use of odd lengths by purchasers should be encouraged wherever a market for odd-length lumber exists or can be developed.

Allowances for Trimming.

The scaling length clause of Form 202 specifies a definite allowance for trimming. This allowance should be adapted to different logging conditions and to large and small timber. Three inches overrun will ordinarily be sufficient for small timber where the danger of brooming is slight; 6 inches may be reasonable in sales of large timber or where the danger of brooming in driving or chuting is great.

MEASURING, NUMBERING, AND STAMPING LOGS**Measuring Log Lengths.**

The length of all logs about which there is any question in the mind of the scaler will be measured. In addition, the length of logs in the general run will be measured frequently enough, preferably directly after the sawyers, to make sure that the specified trimming allowance is not exceeded and that the proper variation of log lengths to obtain the best utilization is followed. Any logs overrunning the trimming allowance will be scaled to the next foot in length, as outlined under "Penalty scale," page 27.

Frequent measuring is of special importance in small sales where a scaler is not always present, since sawyers are more apt to be lax than when the lengths are checked daily by a forest-officer.

Measuring Diameters.

All diameters will be measured inside the bark at the top end of the log. Diameters will be rounded off to the nearest inch above or below the actual diameter. Logs which have a diameter exactly half way between inches will be thrown to the next lower inch.

If logs are not round, they will be scaled on the average diameter. Several diameters may be measured where necessary to obtain a fair average. The average thus obtained represents in effect the top diameter of the log, and should be so treated in scaling. For example, if two measurements taken are 33 and 38 inches, the average diameter is $35\frac{1}{2}$ inches and the log is scaled as a 35-inch log. The practice of alternately using the higher and lower diameters in logs with tops of irregular diameters will not be followed. When at the scaling end of a log there is a swelling from which no lumber can be cut, the necessary reduction in diameter will be made.

Numbering Logs.

Every log, whether merchantable or cull, must be numbered with crayon at the time it is scaled, except under conditions which in the opinion of the regional forester will permit no subsequent use of the numbers, in which case a specific waiver of the requirement will be made by him. It is frequently convenient to number all logs in a rollway, and then scale and stamp them, thus making sure of an entry in the scale record for each log in the rollway.

The scale of each merchantable log will be entered opposite the log number in the scale book in the column provided for that species.

The gross scale of each cull log brought to the place of scaling will be entered opposite the log number in the scale book, either in a circle, or in the column provided for defect, and the word "cull" or the letter "C" entered in the species column. Cull logs scaled and entered in the scale books will be counted as pieces and reported as logs of their particular species.

Merchantable logs left in the woods and penalty scaled should be numbered so that in case of complaint by the purchaser they can be readily identified. Unless required by the regional forester in ascertaining the cull percentage on sale areas or for some other reason, the numbering and recording of cull logs not brought to the point of scaling will not be necessary.

Numbering, as a feature of Forest Service scaling, is essential for the following reasons:

(1) It is a check on the total number of pieces scaled and prevents the missing of logs.

(2) It fixes the responsibility of the scaler by individual logs. It is thus a safeguard against lax scaling.

(3) It permits an exact check on the scale at any time. This is desirable even when logs are manufactured immediately, and enables the supervisor, check scaler, or inspector to make a check whenever the sale is visited, if only for a half dozen logs.

(4) It affords a definite basis for settlement of complaints and is a protection to the purchaser.

Scale-Book Letters.

In sales which require the use of more than one scale book, the books should be lettered serially with the letters of the alphabet, in the order in which they are used. In order to avoid confusion in recording the scale of logs in several small sales to the same purchaser in which logs are brought to adjoining landings a different series of letters may be used for each sale in addition to the differences in dates of the sales.

In large sales, serial numbers need not be continued throughout the contract, since numbering is intended only for the identification of individual logs. In such sales the scale-book letter on the end of each log prevents confusion. It is usually sufficient to number logs consecutively to the end of each scale book, beginning the next book with No. 1. There should as a rule be an unbroken series of scale-book letters covering the cut of each logging season.

End Check on Logs.

Where a series of scale books is to be used on one sale, the serial letter of the book in which the log is recorded will be placed on the opposite end of the log from the number. In sales of all sizes, stamping on the end opposite from the number is also to be preferred. This practice aids the check scaler in locating the original scale entry, insures getting all the logs in a deck or skidway, and automatically requires the scaler or scalers to see both ends of the log.

Stamping Logs.

Every log scaled will be stamped "U. S." on at least one end, preferably the end not used in numbering. The stamp signifies an official scale, subsequent to which title to the timber, previously paid for, passes to the purchaser. The removal or use of unstamped timber is a breach of the contract. Logs so defective as to be unmerchantable under the terms of the sale agreement will be plainly marked in one of the following ways as prescribed by the regional forester: (1) With a circle around the stamp thus,

(U S); (2) with the word "Cull" and the initial of the scaler, in addition to the "U. S." stamp.

It is essential that cull logs be plainly distinguished from merchantable logs in the manner prescribed in order to identify the culling as done by a forest officer. The distinguishing mark should be made as permanent as possible. This is necessary to show the disposition made of the log in the event of another officer taking charge of the sale, of checking the area over for penalty scale, or of subsequent inspections of the cutting.

It is essential to distinguish sharply between logs which are merchantable under the rule as to percentage of sound contents specified in the contract and cull logs. No logs should be stamped as merchantable which do not scale the percentage of their gross contents required by the sale agreement. Any log not meeting this qualification should be culled. Free use of all material unmerchantable under the terms of the sale agreement should always be permitted for sale improvements. Its removal and use for other purposes is discretionary with the regional forester. Logs consisting in part of merchantable and in part of unmerchantable material will be charged for at the contract price for merchantable contents if the merchantable portion would be subject to penalty scale. (See penalty scale on page 27, the merchantability clause, Form 202, and "Utilization Requirements" in the National Forest Manual.)

Check on Total Number of Logs.

Unless the logs have been numbered or marked on both sides of the pile or skidway, a practice frequently followed where two men scale together, the logs in each pile or skidway will be counted after scaling, and the total checked with the number of entries in the scale book.

DEDUCTIONS FOR DEFECTS

The effect of rot and other defects upon logs of different species and in different regions varies so greatly that no rules for making deductions can be applied inflexibly. The constant exercise by scalers of good judgment based upon an accurate knowledge of local timber secured by seeing defective logs opened up under the saw is essential.

Defects are classified as follows (fig. 1):

- (1) Interior defects, which cause waste in the interior of logs.
- (2) Side defects, which cause waste on the outside of logs.
- (3) Defects from curve or sweep.
- (4) Defects from crotches.
- (5) Defects from an excessive number of knots in top logs.

Standard Rule.

The most accurate method of mathematically reducing the scale for interior defects showing in one or both ends of the log is to treat the defects as sawed out in squares or rectangles. The Scribner decimal C rule is based upon diagrams of 1-inch boards with $\frac{1}{4}$ -inch kerf. Twenty per cent of any square or rectangle inside the slabbed surfaces of the log is, therefore, deducted for kerf in the rule. This deduction is carried in scaling sound timber, and hence should not be included in allowances for defect.

The scaler first measures the end dimensions of the square or rectangle which will be wasted in manufacture and determines its length. A slight allowance in excess of the dimensions bounding the actual defect is made to cover the loss in sound material surrounding the defect which must be discarded with the defective material. This incidental loss, which will ordinarily be taken to be 1 inch, is added to the actual diameter of the defect to give its total dimensions. From its computed contents in board feet 20 per cent is deducted as the scale rule's allowance for saw kerf and the remainder raised or lowered to the nearest 10. The gross scale of the log is then reduced by this amount.

The substance of this method is to deduct 80 per cent of the board-foot contents of a piece of timber having the same dimen-

sions as the defect. The entire process may be stated algebraically as follows: If a and b represent the end dimensions of the defect in inches, l the length of the defect in feet, and X its contents in board feet after 20 per cent is deducted for kerf, X , or the net reduction to be made in the scale, may be obtained as follows:

$$X = \frac{a \times b \times l}{12} \times \frac{80}{100} = \frac{a \times b \times l}{15}$$

X must then be raised or lowered to the nearest 10.

Table 3 of the appendix gives, in lengths of from 4 to 40 feet, deductions for interior defects which square from 2 to 30 inches.

Table 2 gives deductions for similar defects which must be cut out in rectangles.

Ordinarily where defects of these classes show in both ends of the log the larger dimensions are taken in logs 16 feet and under in length, and the average dimensions in logs over 16 feet. If a defect does not appear in both ends of the log the scaler estimates its length, taking the other dimensions in full as shown at the defective end. An exception to the practice of taking the larger dimensions of the defect in logs 16 feet in length or shorter where the defect extends the entire length of the log is permissible in regions where shorter lumber lengths than 8 feet are merchantable. In such cases it is permissible to use the average diameter obtained by taking the diameter of the defect at both ends of the log.

Where logs are cut in long lengths and divided into two or more logs for scaling, the diameter of the defect for each log will be obtained in the same manner as for taper. It must be remembered that ordinarily the large end of the defect will be used in making deductions for the individual logs.

Where the defect occurs in one end of the long log only, the scaler will determine the length of the defect by a close inspection of the log for surface indications. Interior rots, with the exception of butt rots, can almost invariably be detected by punks, punk scars, or rotten knots. In logs which have defect in one end but which have no surface indications on the sides of the log to aid in determining the distance that the defect extends into the log, the scaler will be guided by such local instructions as are issued by the region in which he is working. Unless local studies have definitely established the action of the various fungi with reference to their surface indications, it will be necessary for the scaler to use the diameter of the visible defect on the end of the log in determining the necessary deductions.

SCALING AND MEASUREMENT

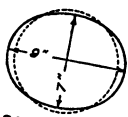
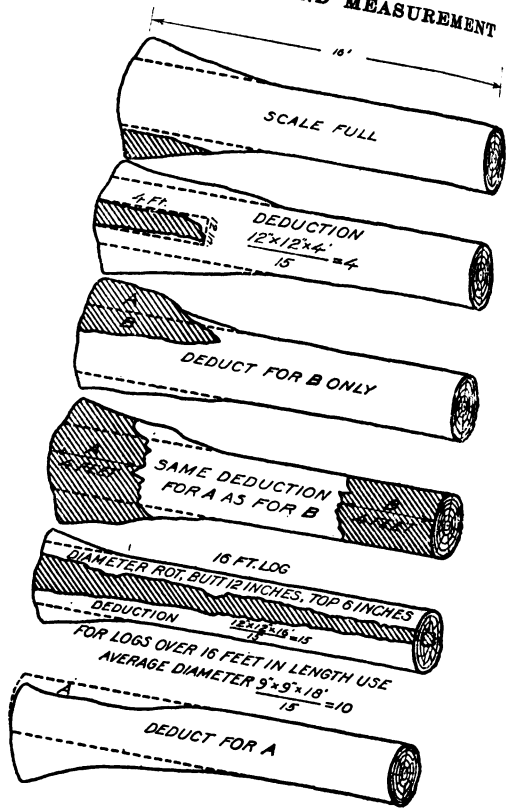

SCALE AS 8"



UN SOUND PORTION

FIG. 1. - Diagram of common defects of logs

Rules of Thumb.

It will be the standard practice in Forest Service scaling to use the above rule (see Tables 2 and 3), in deducting for interior defects. For deducting for center and circular rot, regional foresters may, however, approve the use of other rules, such as the three rules of thumb given below, by scalers who have the requisite judgment and experience.

(1) Obtain the average diameter of the rot. Add to the average diameter:

One half, if it is 9 inches or less.

One third, if it is from 10 to 19 inches, inclusive.

One-fourth, if it exceeds 19 inches.

Obtain the scale of a log of this diameter, as extended, and of the same length as the log in question. Deduct this amount from the gross scale of the log.

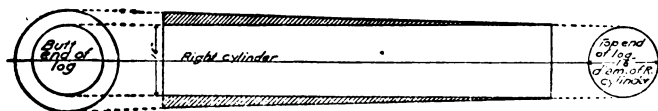

FIG. 2.—The right cylinder of a log

(2) In the case of 14 or 16-foot logs only, the deduction for circular rot of 8 inches in diameter or less can be obtained by squaring the diameter of the defect in inches and rounding off to the nearest multiple of 10. If the average diameter is 7 inches, for example, its square would be 49, or rounded off, 50 board feet. (Read as 5 in Scribner decimal C log rule.)

(3) For center defects not over 17 inches in diameter, allow twice the scale of a log having the length and diameter of the defect. Within the size limitation indicated, this rule will give results very similar to the use of the standard rule. It should not be used for defects over 17 inches in diameter.

It should be kept in mind that in measuring the diameter of the defect under the rules of thumb, the measurement should be taken in the same manner as it would be taken in applying the standard rule in the region concerned.

The Right Cylinder.

Figure 2 illustrates the right cylinder of a log. Defect falling without the right cylinder will not be taken into consideration in making deductions. Where the standard rule is used in making deductions for defects which extend to the margin of the log

it must be remembered that only the defect which falls inside the slabbed surface as well as inside the right cylinder will be considered. The reason for this is that while the Scribner scale rule makes allowance for the slab, the method used in applying the standard rule for deducting defects does not. It will be Forest Service practice where the question of slab is involved to allow 1 inch on the radius inside the right cylinder for slab.

The Average Diameter of Logs.

In obtaining the average diameters of logs, care should be taken to ignore slight abnormal swellings. For instance, in

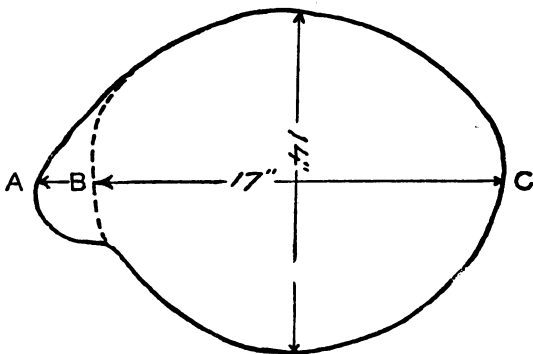

FIG. 3.—Method of determining average diameter of a log

Figure 3, BC rather than AC would be taken in determining the long way of the diameter. The average diameter would be $14 + 17 + 2 = 15\frac{1}{2}$, or dropping to the next lowest inch, 15 inches.

Center or Circular Rot.

Figure 4 illustrates a 16-foot log containing center or circular rot extending the entire length of the log. In determining the deduction on 16-foot logs the usual practice of the Forest Service is to take the large end of the defect. By the standard rule, 1 inch is allowed for waste in sound material which will be wasted in sawing out this defect, so that the average diameter of the defect illustrated in Figure 4 will be considered as 11 inches + 1 inch = 12 inches. $\frac{12 \times 12 \times 16}{15} = 154$ or rounded off to the nearest

10=150 board feet. The gross scale of a 20-inch log inside bark is 280 board feet; so the net scale is $280-150=130$ board feet. Where the sale agreement fixes the merchantability of logs at not less than $33\frac{1}{2}$ per cent of the gross scale this log would be merchantable. If the sale agreement fixed 50 per cent of the gross scale as the minimum the log would be a cull, since 50 per cent of the gross scale would be 140 board feet.

In regions where the value of the species makes possible the utilization of lumber shorter than 8 feet, it is permissible to take the average diameter of the defects in making the deduction in 16-foot logs. In this case the deduction would be $11+7=18$; $18+2=9$ inches. Allowing 1 inch margin, $9+1=10$, or $\frac{10 \times 10 \times 16}{15} = 107 = 110$ board feet, and $280-110=170$, the net scale.



FIG. 4.—Deduction for defect caused by center or circular rot

Had this log been longer than 16 feet the average diameter as found by taking a measurement of the defect at both ends of the log would have been taken. For instance an 18-foot log would be treated as follows: $\frac{10 \times 10 \times 18}{15} = 120$ board feet. An

18-foot log 20 inches in diameter scales 310 board feet, and so the net scale is $310-120=190$. In regions where logs longer than 16 feet are scaled as two or more logs, the amount of deduction to be made for this 18-foot log will be found by determining the defect for each individual log into which the long log will be divided. The total net scale for the two logs will be recorded in the scale book as the scale of an 18-foot log, viz: The long log will be divided into a 10-foot log and an 8-foot log. The big end of the defect at the end of the 10-foot log will be 11 inches as given, and the diameter of the big end of the defect in the 8-foot log will be 9 inches ($11+7=18$; $18+2=9$). Assuming that the butt end of the long log has a diameter of 22 inches, the top diameter of the 10-foot log would then be taken as 21 inches and the top diameter of the 8-foot log as 20 inches. The deduction for

the 10-foot log would be $11 + 1 = 12$, $\frac{12 \times 12 \times 10}{15} = 96$ board feet = 100 board feet. The deduction for the 8-foot log would be $\frac{10 \times 10 \times 8}{15} = 53$ board feet = 50 board feet. The scale of a 10-foot log 21 inches in diameter is 190 board feet. The scale of an 8-foot log 20 inches in diameter is 140 board feet. Then $190 + 140 = 330$ board feet and $330 - (100 + 50) = 180$ board feet, the net scale.

Where logs are bucked in the woods in long lengths merely for convenience in logging and are cut into shorter lengths at the mill before sawing, the scaler will consider the logs into which the long log is divided for scaling as individual logs in so far as cull logs are concerned. For instance, if one of the 16-foot logs which goes to make up a 32-foot stick is a cull log under the merchantability clause of the sale agreement, the net scale of the other 16-foot log only will be considered in recording the scale of the 32-foot log. In other words, any net scale which it may be possible to obtain in the cull log will not be taken by the Forest Service.

Where the defect shows upon one end of the log only, the diameter of the visible end of the defect will always be taken and the scaler will estimate the distance the defect extends into the log. If the defect in the log in question (fig. 4) extended into the log 8 feet the deduction would be $\frac{12 \times 12 \times 8}{15} = 77 = 80$ board feet.

Should the defect extend into the log 10 feet in a region where 8-foot lumber is not merchantable, the defect would be taken as having a length equal to that of the log. The scaler will be guided in estimating the length of defect by experience gained in seeing logs opened up at the mill, by surface indications, and in some cases by definite instructions issued by the region in which he is working.

Ground or Stump Rot.

Ground or stump rot in butt logs seldom extends far into the log and usually tapers to a point.

Figure 5 illustrates a 16-foot log scaling 210 board feet with a stump rot in the butt having an average diameter of 14 inches. The deduction would be made by cutting off 4 feet in the length of the log, giving the log the scale of a 12-foot log, 18 inches in diameter, viz: A 16-foot log 18 inches in diameter scales 210 board feet. A 12-foot log 18 inches in diameter scales 160 board feet. Amount of deduction is 50 board feet.

In this case the standard rule would give a deduction figure greater than the actual scale of a 4-foot section of the log, viz:

$14 + 1 = 15$, $\frac{15 \times 15 \times 4}{15} = 60$ board feet. This is due to the fact

that when the diameter of the defect is so large as to approach the diameter of the right cylinder the volume of the square defect is greater than the board-foot volume of a right cylinder having the same diameter. If the defect in this case had been, say, 7

inches, by the standard rule the deduction would have been $7 + 1 = 8$, $\frac{8 \times 8 \times 4}{15} = 17 = 20$ board feet. Therefore, in cases where

the deduction obtained by the standard rule is greater than the deduction obtained by reducing the length of the log (for the same length of defect) the latter method will be used. It should

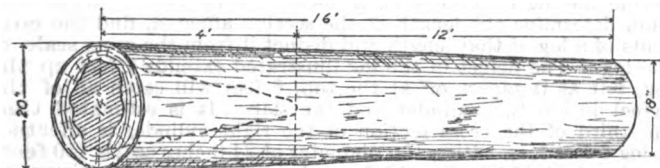

FIG. 5.—Deduction for defect caused by stump rot

be clearly understood that no fixed rule can be established as to the distance stump rot will extend into the log. An extreme case has been taken in the illustration given here in order to bring out a condition where the standard rule can not be used. In many cases a rot occupying as large a portion of the end of a butt log as given in the illustration would extend into the log a greater distance than 4 feet.

Other Fungous Rots.

It is difficult to prescribe general methods for making deductions for defects caused by the various species of fungi, because of the different action of a particular fungus in different species of trees and under different soil and climatic conditions. A single punk of the fungus *Trametes pini* on a log of western white pine in the north Idaho region usually indicates rot extending 2 feet toward the top of the log and 4 feet toward the butt, while with the same fungus in Douglas fir in the Pacific coast region the rot will extend from a single point of infection as

much as 20 feet. It is therefore thought best to have each regional forester issue such special instructions as he may see fit covering the practice to be followed in making deductions for those rots which do not come under the classification "center or circular rot." Two very good discussions on the behavior of the different rots and the methods to be used in making deductions for them in western conifers will be found in Clyde E. Knouf's "Trade Course in Log Scaling for Idaho Woods," published by the Idaho Board of Vocational Education, and E. J. Karr's pamphlet, entitled "Log Scaling in the Douglas Fir Region." This latter publication was also published in the April, 1920, issue of the *Timberman*.

Cat Face or Fire Scar.

Figure 6 illustrates a 16-foot log which has been damaged by fire. The most common method of deducting for defect is to divide the log into sections, throwing all the waste into one section, determine the length of the section affected, find the contents of a log of that length and deduct it from the gross scale of the log. The defect in the log illustrated extends 7 feet up the log, but as it tapers off at the top, 6 feet will catch all of the defect inside the cylinder and the slab. It is estimated that one-third of the cross section of the right cylinder is affected. A log 6 feet long with a top diameter of 24 inches scales 150 feet; one-third of 150 feet is 50 feet, the amount of deduction. A 16-foot log 24 inches in diameter scales 400 feet, so that the net scale is $400 - 50 = 350$. Or, to state it another way, one-third of 6 feet is 2 feet; and cutting the length of the log 2 feet we have a 14-foot log with a 24-inch diameter, scaling 350 feet.

Figure 7 shows the method of applying the standard rule to this defect. Allow 1 inch for slab inside the right cylinder; with the scale stick get the depth, average width, and length of the defect, viz: $\frac{8 \times 17 \times 6}{15} = 54$ or rounded to 50 board feet.

Shake or Pitch Ring.

Figure 8 represents a 16-foot log scaling 210 board feet. A center shake 10 inches in diameter in the butt extends clear through the log. The standard rule or the rules of thumb given on page 15 should be used in determining the deduction to be made for this defect. By the standard rule the deduction would be $10 + 1 = 11$, $\frac{11 \times 11 \times 16}{15} = 129 = 130$ board feet. A 16-foot log, 18 inches in diameter scales 210 board feet and $210 - 130 = 80$ board feet. This would be the net scale if all of the material

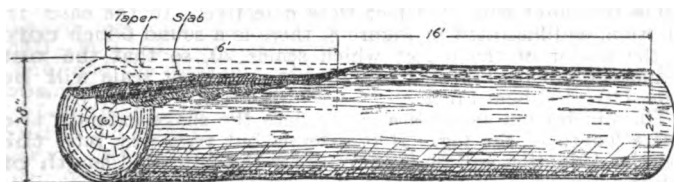

FIG. 6.—Deduction for defect caused by fire scar

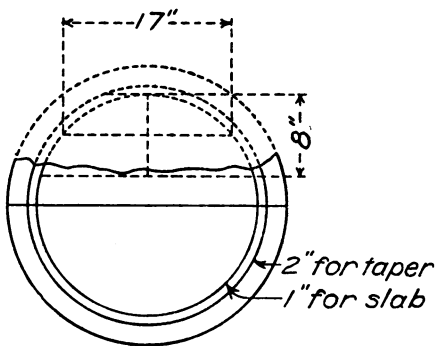

FIG. 7.—Application of standard rule for determining defect caused by fire scar

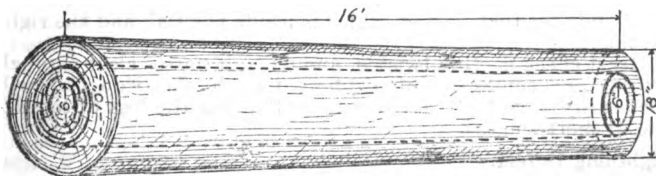

FIG. 8.—Deduction for defect caused by center shake

inside the outer ring of defect were defective. In the case in question, as illustrated in Figure 8, there is a sound 6-inch core in the center of the defect which scales 20, so that the net deduction will be $130-20$, or 110 feet. The net scale will be $210-110=100$ board feet.

The illustration assumes a case where the shake extends the entire length of the log. If it extends but part way into the log, the deduction will be made only for the estimated length of defect.

Heart Check, Pitch Seam, or Split.

Figure 9 illustrates a 16-foot log with a heart check extending part way across the butt end. The length of the check is 18 inches inside the right cylinder and slab, and it is estimated it will require an allowance of 3 inches in width to eliminate the waste in sawing. It is estimated that the defect extends into

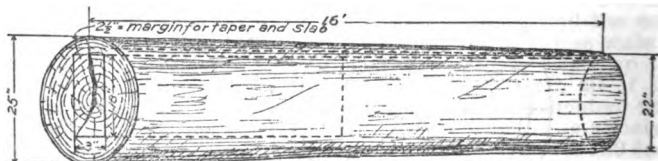

FIG. 9.—Deduction for defect caused by heart check

the log 8 feet. Deductions for defects of this nature should be made by the standard rule. The amount of the deduction is $\frac{3 \times 18 \times 8}{15} = 29 = 30$ board feet. It will be noticed that although

the defect extends clear to the outer edge of the log deduction is made only for that portion which is inside the slab and the right cylinder.

Heart check is often twisted, and when it passes clear through the log and comes out at a different angle the deduction will necessarily have to be increased to allow for the loss of lumber due to short lengths.

Lightning Defect.

The log shown in Figure 10 has a severe lightning scar down its entire length. By dividing the log into sectors the entire defect can be thrown into one sector, which here constitutes one-fourth of the butt end of the log. Since the defect extends the entire length of the log one-fourth of the gross scale is lost.

The gross scale of a 16-foot log 19 inches in diameter is 240 board feet and one-fourth of 240 is 60. The net scale is $240 - 60 = 180$. Or one-fourth of 16 feet is 4 feet, $16 - 4 = 12$ feet, and the scale of a 12-foot log 19 inches in diameter is 180 board feet.

Lightning scars are very often a point of entrance for fungi and in old scars an additional allowance for rot is usually necessary. Also lightning damage does not always occur in a straight line as given in the illustration, but frequently takes a slightly spiral course.

Where a lightning streak spirals clear around the log, deduction can be made by scaling the log as the cylinder inside the defect, or, if it runs only say quarter way around the bole, by deducting one-fourth of the difference between the full scale of the log and the scale of a log taken inside the defect. If, for instance, in the log in question the lightning streak had cut into

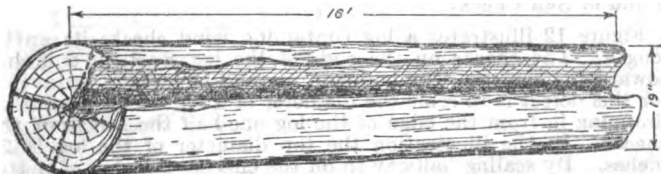

FIG. 10.—Deduction for defect caused by lightning

the surface of the log 4 inches and spiraled around one-fourth of the log, the deduction would be made as follows: Scale of a 19-inch 16-foot log is 240 board feet. Scale of a 15-inch 16-foot log is 140 board feet. The amount of deduction to be made is $\frac{240 - 140}{4} = 20$. The net scale is $240 - 20 = 220$.

Crook or Sweep.

Figure 11 shows a 16-foot log 20 inches in diameter at the top, scaling 280 board feet. Half of the log is not affected by the crook; one-third of the other half of the log will not produce the full scale for this portion of the log since the section marked X is lost. Part of the section Y will produce 10, 12, and 14 foot lumber. It is figured that two-thirds of the section X and Y are lost. Section X and Y are figured to be one-third of the scale of the 8-foot section (140 feet) or 46 feet, and two-thirds of this, or 30 board feet, is the deduction. The net scale would then be $140 + 110 = 250$ feet.

It is customary practice to make deductions for crook by merely reducing the length of the log. In this case the log would probably have been scaled as a 14-foot log, 20 inches in diameter, which would give a net scale of 240 feet, or 10 feet less than by the method used above.

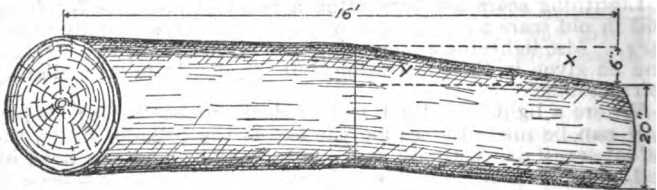

FIG. 11.—Deduction for crook or sweep

Wind or Sun Check.

Figure 12 illustrates a log containing wind checks its entire length. The checks on the ends of the log reach in 6 inches toward the center. The common method of making deduction for this defect is to scale the diameter of a log which results by dropping in from the edge of the log one-half the length of the checks. In the illustration the top diameter of the log is 24 inches. By scaling halfway in on the checks, 3 inches of mate-

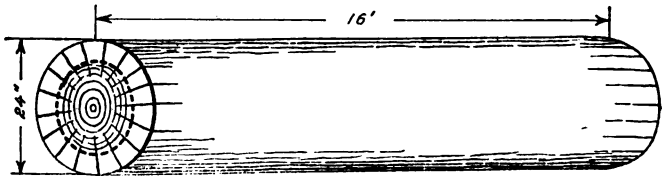

FIG. 12.—Deduction for defect caused by wind checks

rial is excluded clear around the log and the log is scaled as having a diameter of 18 inches. A 24-inch log scales 400 board feet. An 18-inch log scales 210 board feet = the net scale. Deduction is $400 - 210 = 190$ board feet. The reason for not scaling clear inside the checks is that ordinarily the waste due to the checks is not so great in the interior of the log as it is on the ends.

Occasionally only a portion of the log is checked. In such cases the log is divided into sectors (the method is similar to that for lightning defect), all of the waste is thrown into one sector, and deduction made accordingly.

Blue Stain.

Blue stain in itself is not a wood-destroying fungus, but it offers an entrance to other fungi which do break down the structure of the sapwood. Defective sapwood will be deducted or by scaling to the average diameter inside the sap. No deduction will be made for sound blue stain.

Crotch.

Figure 13 shows a 16-foot log with a pronounced crotch at the top end. The dimensions of the top end are 16 and 28 inches, respectively, but it is obvious that an average of these two measurements would not give a true scaling diameter. The proper place to obtain the diameter for scaling this log is just below the swelling. However, since this diameter can be obtained accurately only by use of calipers or a diameter tape it is customary

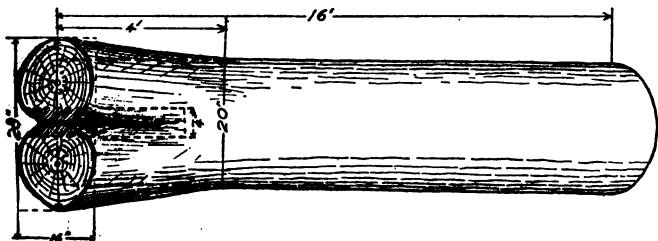

FIG. 13.—Method of scaling a crotched log

for the scaler to measure the butt diameter and make an allowance for taper in determining the top diameter to be used. In this case the diameter obtained is 20 inches and the full scale of the log is 280 board feet. There is bark or lack of wood between the two stems at the top of the log, causing some waste. The waste is in the form of a rectangle 4 inches thick, 16 inches wide, and 4 feet long (3 feet actual length but taken to even length, since odd-length lumber is not merchantable. Applying the standard rule to this defect we have $\frac{4 \times 16 \times 4}{15} = 17$ feet, rounded to 20 board feet. The full scale of 280 board feet less 20 feet deduction is 260, net scale.

In case the crotch is cut off so close to the point of departure from the main stem that the surface of the end of the log is unbroken by bark or split no deduction will be made.

Wormholes.

Figure 14 represents a 16-foot log, 24 inches in diameter, scaling 400 board feet, having wormholes defect brought in by fire damage, occupying 9 inches of the cross section of the log from the butt end to within 4 feet of the top. Since the 4-foot lumber on the end of the defect is not merchantable, deduction must be made for the entire length of the log. To find the net contents of the log take the average diameter of the sound portion inside the right cylinder and obtain the scale of a log of that diameter. The diameter inside the right cylinder is 24 inches; so $24 - 7 = 17$ inches equals diameter of log (the defect is 9 inches minus 2 inches for right cylinder or 7 inches) the narrow way and $(24 + 17) \div 2 = 20$ inches. The scale of a 16-foot log 20 inches in diameter is 280 board feet, which is the net scale.

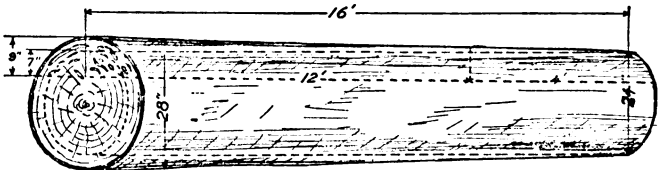

FIG. 14.—Deduction for defect caused by wormholes

Deductions for this type of defect can also be made by the method outlined above for cat face or fire scar.

DETERMINING THE MERCHANTABILITY OF LOGS

The percentage of the total scale of a log which determines its merchantability should always be reckoned from the full scale, including unsound sap, checks, curve, and any other defects present.

SCALING GREEN AND DEAD TIMBER

In sales which include green and dead timber at separate stumpage prices the scaler should not attempt to trace logs from the tree to establish their character, but may classify them on the appearance of the log at the point of scaling.

PENALTY SCALE

The penalty-scale clause of Form 202 provides for liquidated damages to cover losses to the United States which result from leaving material in the woods or cutting contrary to the terms of the sale agreement.

Enforcement of the penalty-scale clause is necessary except in accidental or exceptional cases involving small amounts of timber, where it may be waived by the officer in charge. Whenever waste subject to the penalty-scale clause occurs, the officer in charge will notify the purchaser and call his attention to the utilization required by the sale agreement. In order to avoid later controversy, notification should be given in writing. If further waste occurs, or if material previously left in the woods, the utilization of which is practicable, is not removed, a penalty scale should be made of all such material and reported to the supervisor.

Some of the most common examples of poor utilization which call for penalty scale are:

(1) A log unmerchantable under the terms of the sale agreement due to defect but which would have been merchantable if the length of the log had been reduced by cutting off the end containing the major portion of the defect.

(2) A log unmerchantable due to its top diameter being slightly less than the utilization requirement of the sale agreement but which would have been merchantable had the log been shortened.

(3) Merchantable material on the end of a cull log which should have been utilized by increasing the length of the adjacent log.

(4) Sound material left in cutting out breaks, sharp crooks, etc., or material left in the top of a tree with a greater diameter than the minimum required by the sale agreement and which could have been utilized by increasing the length of the adjacent log.

Penalty material should be scaled as promptly as practicable, and in any case immediately after the completion of operations upon a logging unit.

Material subject to this requirement (penalty-scale clause, Form 202) will be scaled, stamped, and numbered as in the regular scale, and recorded as indicated on page 40.

Scaling Length.

Under the scaling-length clause of Form 202, logs overrunning the specified allowance for trimming will be scaled not to exceed

Wormholes.

Figure 14 represents a 16-foot log, 24 inches in diameter, scaling 400 board feet, having wormholes defect brought in by fire damage, occupying 9 inches of the cross section of the log from the butt end to within 4 feet of the top. Since the 4-foot lumber on the end of the defect is not merchantable, deduction must be made for the entire length of the log. To find the net contents of the log take the average diameter of the sound portion inside the right cylinder and obtain the scale of a log of that diameter. The diameter inside the right cylinder is 24 inches; so $24 - 7 = 17$ inches equals diameter of log (the defect is 9 inches minus 2 inches for right cylinder or 7 inches) the narrow way and $(24 + 17) \div 2 = 20$ inches. The scale of a 16-foot log 20 inches in diameter is 280 board feet, which is the net scale.

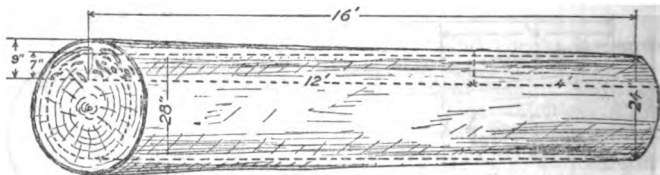

FIG. 14.—Deduction for defect caused by wormholes

Deductions for this type of defect can also be made by the method outlined above for cat face or fire scar.

DETERMINING THE MERCHANTABILITY OF LOGS

The percentage of the total scale of a log which determines its merchantability should always be reckoned from the full scale, including unsound sap, checks, curve, and any other defects present.

SCALING GREEN AND DEAD TIMBER

In sales which include green and dead timber at separate stumpage prices the scaler should not attempt to trace logs from the tree to establish their character, but may classify them on the appearance of the log at the point of scaling.

PENALTY SCALE

The penalty-scale clause of Form 202 provides for liquidated damages to cover losses to the United States which result from leaving material in the woods or cutting contrary to the terms of the sale agreement.

Enforcement of the penalty-scale clause is necessary except in accidental or exceptional cases involving small amounts of timber, where it may be waived by the officer in charge. Whenever waste subject to the penalty-scale clause occurs, the officer in charge will notify the purchaser and call his attention to the utilization required by the sale agreement. In order to avoid later controversy, notification should be given in writing. If further waste occurs, or if material previously left in the woods, the utilization of which is practicable, is not removed, a penalty scale should be made of all such material and reported to the supervisor.

Some of the most common examples of poor utilization which call for penalty scale are:

(1) A log unmerchantable under the terms of the sale agreement due to defect but which would have been merchantable if the length of the log had been reduced by cutting off the end containing the major portion of the defect.

(2) A log unmerchantable due to its top diameter being slightly less than the utilization requirement of the sale agreement but which would have been merchantable had the log been shortened.

(3) Merchantable material on the end of a cull log which should have been utilized by increasing the length of the adjacent log.

(4) Sound material left in cutting out breaks, sharp crooks, etc., or material left in the top of a tree with a greater diameter than the minimum required by the sale agreement and which could have been utilized by increasing the length of the adjacent log.

Penalty material should be scaled as promptly as practicable, and in any case immediately after the completion of operations upon a logging unit.

Material subject to this requirement (penalty-scale clause, Form 202) will be scaled, stamped, and numbered as in the regular scale, and recorded as indicated on page 40.

Scaling Length.

Under the scaling-length clause of Form 202, logs overrunning the specified allowance for trimming will be scaled not to exceed

the next foot in length. If a scaler finds frequent violations of the trimming allowance, he should notify the purchaser, preferably in writing. If further violations occur, he should measure all logs and scale as 1 foot longer any pieces overrunning the trimming allowance. Penalty scaling of this character will be noted plainly in the scale book against the number of the log to avoid possible controversy.

SETTLEMENT OF COMPLAINTS

Complaints should be settled by a check scale. If the results of the first check are questioned upon apparently good grounds a second check should be made by another scaler. It is the policy of the Forest Service to ascertain the justice of complaints by a rescale conducted by a more competent and experienced man, not by lumber tallies or mill checks. Complaints will be settled by mill checks only in extreme and exceptional cases where required by the defective character of the logs or other special local conditions.

If a check scale indicates that a serious injustice has been done the purchaser by errors in scaling, the scale may be adjusted by rescaling all the logs, if available, or, if this can not be done by the regional forester on the basis of the errors shown by the check scale. Decision whether to make an adjustment will be based not only on the percentage of error as shown by the check scale of a necessarily limited number of logs, but also on the character of errors which the check scaler finds have been made. For example, a consistent mistake in determining species sold at different rates may require an adjustment even if the volume of all material check scaled is within a small percentage of the volume as originally scaled.

CHECK SCALING

The chief purpose of check scaling is to make and keep the current scale in all classes of sales accurate by indicating sources of error, and particularly by instructing scalers on the ground. Systematic check scaling is therefore a necessary part of timber-sales administration.

A check scale should be made at least once a year on each sale on which the annual cut is 1,000,000 or more feet. Whenever, as in project sales, one or more scalers are required in addition to the man in charge, a check scale should be made, if possible, of these scalers once a month by the man in charge, lumberman, or other qualified forest officer. Smaller sales

should be checked as frequently as may be necessary to train properly the local officers in charge of them. Checking the scale of rangers who have but little sales work is of special importance, since the largest percentages of error occur in such cases.

Check scaling, as far as practicable, should be done under conditions similar to those under which the original scale was made. As many logs as practicable should be scaled by the check scaler after they have been scaled by the local officer and without knowledge of his figures. Ordinarily 200 to 400 logs will constitute a satisfactory check. The log numbers and scale given in the original scale record for the particular logs on which a check scale has been made will be recorded in the check scaler's book (Form 122). The original scale will be compared with the scale of the check scaler and the results summarized as indicated by the form. In regional forester's and forester's sales and in cases of complaint the record will be prepared in triplicate, one copy for the regional forester, one for the supervisor, and one for the scaler. In all other sales copies of the record will be furnished the supervisor and the scaler only.

Ordinarily a check scale on sound logs should come within 1 percent of the original scale; on logs up to 10 per cent defective, within 2 per cent; on logs 11 to 20 per cent defective, within 3 per cent; and on logs over 20 per cent defective, within 5 per cent. These percentages are intended simply as approximate standards of satisfactory scaling for the guidance of forest officers, not as a basis for changing the original scale.

The original scale will be modified only when found to have been fundamentally wrong in method or in treatment of important defects and when it is clear that serious injustice has been done to the purchaser. Changes will be made only with the approval of the regional forester.

MILL-SCALE STUDIES

Mill-scale studies are made to obtain accurate data on lumber yields and overrun by grades, for use in stumpage appraisals. Wherever practicable, especially in the case of defective timber, logs should be followed through the mill by the scaler to see how they "open up," in order to train his judgment in allowing for defects and other features of scaling. But it is the policy of the Forest Service to use check scaling in investigating complaints and not to make mill-scale studies at a purchaser's mill for this purpose.

SCALING FROM THE STUMP

Use of Stump Scales.

A stump scale is obviously less accurate than a scale of logs, even when measurements are made most carefully. Stump scales should never be used, therefore, when log scales are practicable. This method will be employed only in timber trespasses and other cases where the logs have been removed and a log scale is impossible.

In Timber Trespass.

The total log lengths cut from each tree should be measured in making a stump scale of a timber trespass. Often the indentation in the ground where the butt struck in felling can be located. From that point, which may be several feet from the stump, the total log length should be measured to the top, the direction of which can usually be determined by the undercut on the stump. The total length should be divided into logs in accordance with Taper Tables 9 and 10, appendix, and the instructions on page 7. The diameter of each log should be ascertained from the table or estimated from the total length and the top and stump diameters. The scale of each log may then be obtained from a scale stick or Table 1, appendix. Merchantable timber left in tops, in high stumps, and in unused logs should be scaled and entered separately. After each tree has been scaled the top of the stump and the butt of the top should be stamped "U. S." Deductions from the scale should be made for cull in accordance with the best data available for the class of timber concerned.

Where the tops can not be identified or have been moved or destroyed by fire, the scale may be obtained from the best volume table available for the locality and species by reducing the diameter at the top of the stump to diameter breast high. Volume tables may be used in lieu of stump scales, particularly when heights can be checked on trees bordering the cutting, if the results of this method are believed to be more accurate.

Forest officers should use extreme care in scaling trespass timber, especially by a stump scale, and should keep complete notes of the method used. If the case is brought into court, the scale and methods used in detail must be introduced as legal evidence.

TREE MEASUREMENT INSTEAD OF LOG SCALE

Where conditions permit, national forest timber may be sold on the basis of the determination of the volume in the trees before cutting. This requires the measurement of the diameter of each tree at the time it is marked or designated for cutting, the estimate of its merchantable length or total height, checked by frequent measurements with a height measure and by measuring down trees, and the determination of its merchantable volume from previously approved volume tables. Where material is charged for on this basis a permanent record will always be made of the estimated volume of the individual tree. The volume should be recorded in the regular scale book by entering the net volume of the tree opposite the tree number. If any deduction is made for defect, the amount of deduction, inclosed in a circle in the same manner as for defective saw logs, may be entered in the net column. The usual method of marking will be followed in designating the trees for cutting, and the number of the tree will be recorded with crayon on the upper blaze. This record will permit checking the man responsible for measurements by individual trees; such check will, of course, have to be made before the timber is removed.

Since stamping of the trees, with the "U. S." stamp authorizes cutting and removal, care should be taken not to mark more timber than is on a going sale covered by the funds on deposit. It is customary in sales large enough to justify more than one payment, to call for deposits in advance of marking and then to designate just enough trees to come safely within those deposits. (See "Tree measurements," p. 95-S, National Forest Manual.)

Sales by tree measurement may be made for any desired product, including cordwood by the cubic-foot unit of measurement. Cubic-foot volume tables based on diameters outside the bark are not available for western species, but they can be readily constructed if the region concerned has a sufficient number of sales of this character to justify the effort. Procedure in the sale of other products will be the same as outlined for sales where the board-foot unit is used.

CUBIC MEASUREMENTS

Policy.

The cubic content of timber may be measured (1) by the cord or (2) by the cubic foot. Cubic-foot measurements may, for determining stumpage payments, be converted into cords or

board feet in accordance with a converting factor specified in the sale agreement.

Merchantable Timber.

Standards of merchantability should be specified in sale agreements as in sales of saw timber. These standards should conform to the best trade practice for each species and class of material in the region and as far as practicable should cover the points specified on pages 5 and 6 for material measured by log scale, namely, minimum length of merchantable pieces, minimum diameter, proportion of defective material admissible, and treatment of common defects in scaling.

Requirements of Purchasers.

The requirements of purchasers will be similar to those in saw-timber sales. (See p. 6.) Ricks for cord measure must be sufficiently regular to permit reasonably accurate measurement.

In sales of shingle stock where the officer in charge may determine the number of bolts to the cord, purchasers should be required to rick bolts only in case of question as to the proper number or to check the number currently used.

Check Measurements.

Check measurements will be made in accordance with the instructions for "Check scaling," page 28. The same procedure should be followed as regards the frequency of checks in sales of varying size, the methods of conducting and reporting the check, and action to rectify the original scale.

CORD MEASURE

Policy.

Fuel wood will ordinarily be sold by the cord. Pulpwood, shake and shingle bolts, cooperage bolts, furniture bolts, acid wood, and bark may be sold by the cord or by other units of measure common in the local trade. In sales of shake or shingle bolts the unit of measure will ordinarily be the sound cord—that is, sound material equivalent to 1 cord—rather than the measured cord, which may include some defective material. This requires throwing in additional bolts to make up for defective parts of the bolts constituting a measured cord. The same rule may be followed in the case of other material sold by the cord, if it is desirable to draw the sale agreement in this form.

If cord dimensions differing from the standard of 8 feet long, 4 feet wide, and 4 feet high, with a volume of 128 cubic feet, are to be used, they should be specified in the sale agreement, as when

the long cord, 8 by 4 by 5 feet, with a volume of 160 cubic feet, is to be used for pulpwood or bark, or widths narrower than 4 feet are to be used for fuel wood or bolts.

Cord Measurements.

Measurements of ricks will be taken with a tape in feet and tenths. Where ricks are standing on slopes, the length of the rick parallel to the slope will be measured and the height at right angles to this plane. If end stakes are used, the length of ricks should be measured one-half of the distance between top and bottom; otherwise, at two or more places to obtain a fair average. The height should be measured at several places to give the true average.

In sales of fuel wood where the majority of the pieces in a rick are 3 inches more or less than the standard lengths, the rick should be measured, computed, and charged for on its actual cubic contents.

In sales of bolts of specified dimensions the lengths should be checked sufficiently to make sure that they do not regularly overrun the allowance specified in the sale agreement. If overrun is general, the procedure should follow that outlined under penalty scale on page 27.

To compute the number of standard cords of 128 cubic feet in ricks 4 feet wide, multiply the height by the length of the rick in feet and divide by 32. If the length of the wood is greater or less than 4 feet, multiply length, width, and height and divide by 128.

Stamping and Numbering.

Both the top and bottom of each rick and at least 12 pieces in each cord must be stamped. Each rick will be numbered. The measurements and contents of each rick should be entered opposite its number in the scale book. Where bolts are counted and the number per cord estimated by the forest officer, each bolt should be stamped.

CUBIC-FOOT MEASURE

Policy.

Sales by cubic-foot measure will be encouraged in order to place timber measurements on a more exact basis and permit accurate comparison of scientific and practical data. It will be the standard policy of the Forest Service to sell pulpwood by the cubic foot, with a converting factor equivalent to cords or board feet named in the sale agreement where necessary. The specification of a converting factor makes it possible, particularly in the case of fuel or pulpwood, to adjust the method of

measurement to the form in which the material is cut. The basis of measurement in sales of other classes of material should be changed to the cubic standard whenever practicable.

Measurements.

Two measurements are necessary—the average diameter of the log at its middle point in inches and its total length in feet. The former may be determined by means of calipers and the latter by tape. If the log is irregular in shape the average middle diameter should be determined.

Proper deductions should be made for the thickness of the bark. Recorded diameters should be rounded off to the nearest inch above or below the actual measurement. Logs having a diameter exactly halfway between inches will be thrown to the next lower inch.

The length of logs should be obtained in feet. Lengths should be rounded off to the nearest foot above or below the actual measurement. Logs whose length is halfway between feet should be thrown to the next lower foot. Pieces exceeding 40 feet in length should be measured as two logs of as nearly equal length as possible, and pieces exceeding 80 feet as three logs. When pieces are measured as two or more logs the contents allowed for the separate lengths should be added and the total recorded as one log.

The volume in cubic feet may be obtained directly from Table 4, appendix, which contains the solid contents of logs in cubic feet for average middle diameters from 3 to 60 inches, and for lengths from 4 to 40 feet.

Table 8, appendix, gives the area in square feet of circles from 1 to 80 inches in diameter. This may be used for computing volumes in cubic feet, by multiplying the area of the middle cross section of the log in square feet by the length.

Deductions for Defect.

Deductions for defect should be made, in cubic-foot measurements, in accordance with the general methods discussed for scaling saw timber, page 12. The solid volume in cubic feet of waste material as determined by the surface dimensions of the defect in square or rectangular form, times its length, should be deducted from the total cubic volume of the log. Since no allowance is made for saw kerf in cubic measurement, the 20 per cent reduction required in determining net loss of log scale by the board foot does not apply in this case.

Unless it is certain that the logs will be sawed into lumber, no deductions should be made in cubic-foot measurements for

curve or sweep, crotches or knots. Deductions should be made, however, for unsound material of any character which affects the merchantability of the log for the particular product of the sale.

LINEAR MEASUREMENTS

Policy.

Lagging, posts, piling, fence poles, converter poles, telephone poles, stulls, and mine timbers may be sold by the linear foot.

Merchantable timber.

The instructions under "Definition of merchantable logs," page 5, should be followed. Timber-sale contracts should specify the minimum length and top diameter of sticks classed as merchantable for each product. Maximum lengths and diameters should be designated in contracts under which higher prices are to be paid for products cut from the larger material. It is especially necessary in sales of cedar covering both poles and other products to specify the dimensions of material to be used for each product.

Similar specifications should cover wherever necessary the amount and kinds of defect admissible in products sold by the linear foot or the character of the material held to be merchantable for these purposes. This is of special importance in the case of valuable products like telephone poles and stulls which usually require the best grades of timber. Unless Forest Service specifications are available, the current specifications of local associations of pole dealers and the like with regards to the area of defect admitted in the butts of poles of various diameters and similar points affecting merchantability should be followed.

Requirements of Purchasers.

The requirements of purchasers will be similar to those specified on page 6. If products sold by the linear foot are to be cut in several standard lengths, purchasers may be required to pile or deck each length separately, provided this is practicable and is necessary to permit economical measurement.

Measurement.

Measurements of length only are required. Where pieces are cut in uniform, standard lengths, actual measurement is necessary only in doubtful cases and at short intervals to check the lengths employed by the choppers. When several products are cut in the same sale, or prices depend upon both diameter and length, a similar current check should be made of the diameter of linear-foot material.

The standard allowance for trimming in cutting telephone poles is 1 inch for each 5 feet of length. Penalty measurements for lengths in excess of the trimming allowance will follow the provisions of the contract in accordance with the procedure outlined under "Penalty scale," page 27. Wherever advisable sale agreements should specify trimming allowances for other classes of material.

Board-Foot Equivalents.

If desirable, sale agreements may specify the equivalent in a thousand feet board measure for a stated number of linear feet. This facilitates the application of a flat stumpage rate. As a standard practice, however, it is preferable to require payment on a linear-foot basis.

Stamping and Numbering.

Each stick measured must be stamped on at least one end.

Each pile of material measured should be numbered with crayon in the case of lagging, posts, fence poles, converter poles, or other material individual pieces of which are small and of little value. The number of pieces in each pile and their linear-foot contents will be entered opposite the pile number in the scale book. Large pieces, like telephone poles, piling, and 16-foot stulls, equivalent in value to saw logs, should each receive a number. The scale of each piece should be entered opposite its number in the scale book.

Check Measurements.

Check measurements will be made in accordance with the instructions for "Check scaling," page 28, and for "Check measurements," page 32.

Combined Linear and Diameter Measurements.

Where the market value of products like telephone poles and stulls varies widely in accordance with top diameter as well as length, a schedule of stumpage rates for the various lengths and sizes should be used. In such sales the top diameter of each piece must be accurately measured, an average diameter being obtained in the case of sticks of irregular shape. Diameters will be averaged to the nearest inch, unless taking the next lower inch has been agreed upon in advance with the purchaser and is specifically required by the sale agreement. If different lengths are cut, they should be measured on not less than 25 per cent of the pieces. Every piece should be given a separate number and entry in the scale book, as in the case of saw logs.

COUNTING

Policy.

Hewn ties sold by the piece, in accordance with the standard practice of the Forest Service, will be counted. Ties will also be counted in sales where their board-foot contents are specified by the sale agreement. In the exceptional cases in which ties are scaled the instructions under scaling will be followed. Shingle bolts will be counted when contracts specify that the number of bolts to the cord will be determined by the scaler.

Lagging, poles, posts, etc., will be counted when sold by the piece.

Merchantable Timber.

The instructions under "Definition of merchantable logs," page 5, will be followed unless otherwise provided in the sale agreement. Contract requirements should conform with the local market specifications of the product concerned. Special contract clauses should be used to designate unmistakably the maximum and minimum sizes of pieces which are to be counted rather than scaled. Such clauses should include any specifications as to defect or class of material necessary to establish beyond question what timber is merchantable for these products.

Requirements of Purchasers.

The requirements of purchasers should be similar to those outlined on page 6.

Stamping and Numbering.

When counted, each stick of mine timbers, ties, posts, or poles must be stamped on at least one end.

Each pile of material must be numbered with crayon even though it will be removed immediately. The number of pieces will be entered opposite the number of the pile in the scale book.

Check Measurements.

Check measurements will be made in accordance with the instructions under "Check scaling," page 28, and "Check measurements" page 32.

Sample sheets of Forms 285, 231 and 651, on pages 86, 84, 88, and 90 of the appendix show the proper method of keeping scale records of saw timber.

A sample sheet of Form 285 on page 96 of the appendix shows standard methods of recording measurements and counts of telephone poles and piling sold by the linear foot and piece.

A sample sheet of Form 648, page 98 of the appendix, shows the standard method of recording measurements and counts of

mining timbers sold by the linear foot, and ties and posts sold by the piece. A method of recording ties only is shown on page 100, Form 648.

A sample sheet of Form 285, page 92 of the appendix, shows the standard method of recording cubic feet.

A sample sheet of Form 648, page 94 of the appendix, shows the standard method of recording measurements of fuel wood sold by the cord.

WEIGHING

Bark may be sold by the ton when this method accords with the best trade practice of the region and scales are available on which weights may be taken by forest officers or checked when taken by agents of common carriers. If the long rather than the standard ton is to be used, this must be specified in the sale agreement.

RECORDS AND REPORTS

Scale Books.

The scale or measurement of logs or other material will be entered by scalers directly in one of the following standard scale books, unless not suitable, in which case authority to use a special form of scale book should be secured from the Forester:

Form 231 (small size; for "Free use," "Sales at cost," and "Class A and B sales").

Form 285 (large size).

Form 285a (small size).

Form 285b (large size; used in cooperative scaling).

Form 648 (small size only; used in taking up special products).

Form 651 (large size only).

Form 122 (Comparative Scale Book, for use in check scaling); revised 1927.

Scale records will not be entered in other notebooks or on loose slips of paper to be transferred to scale books later, except under exceptional conditions where the cost of scaling would be materially increased or the purchaser seriously inconvenienced.

Temporary scale records must be transferred to the regular scale book as soon as practicable and the temporary record fastened permanently to the page of the scale book on which the entries are made. The original scale books, after all entries have been made and checked, will be kept in the supervisor's office in all advertised sales, and in the ranger's office in unadvertised sales. Logs, pieces, or piles of material should be numbered and their scale, cubic contents, linear feet, number of sticks, or number of cords, with the other data called for on these

forms, entered opposite each serial number in accordance with the instructions on numbering, pages 9, 33, 36, and 37.

When pieces are scaled as two or more logs the scale allowed for the separate lengths will be added and the total sum recorded as one log.

Similarly, when pieces are measured by the cubic foot as two or more logs, the dimensions of the whole piece should be entered under a single serial number, the cubic contents of the separate lengths added, and the total recorded as one log.

So far as scaling forms allow, the following information should be given for each class of material scaled, measured, or counted:

Saw timber: Serial number of each log, length, net scale, and deductions for defect.

Poles and piling (where sold on piece basis of specified length and diameter): Serial number of each piece, length, and diameter.

Cord material: Serial number of each rick, dimensions of rick in feet and tenths, and its contents in cords and fractions of cords.

Cubic-foot material: Serial number of each log, its length in feet, net contents in cubic feet, and deductions for defect.

Linear material: Serial number of each pile and number of pieces of specified class and length.

Material counted: Serial number of each pile and number of pieces, by special class and length if necessary.

Material weighed: Number of pounds or tons with identification by car shipment or otherwise.

Where no column is provided for cull the net scale of partially defective logs will be entered in the space provided opposite the log number, and the cull deduction (enclosed in a circle thus—Ⓢ) will be recorded in the upper left-hand corner. The gross scale of logs which are wholly cull may be handled in the same manner, except that the word "cull" or the letter "c" will be substituted for the net scale. Entries of the diameter of saw logs and notes on the kind of defect are desirable, in addition to those specified above. They may be required in the discretion of the regional forester.

All logs scaled in tripartite land-exchange cases will be recorded in the regular sale scale books. No separate scale books or separate series of numbers will be maintained in such cases. If it is desired to credit part of the timber cut and scaled during a certain month to land exchange and this involves logs numbered, say, from "400" to "950" as entered in the scale book, a marginal note will be made on the scale-book pages recording

these logs to the effect that they were scaled to the credit of "John Doe-Land Exchange 1-15-16."

Penalty-Scale Records.

Separate scale books will be kept in large sales for material covered by penalty scale under the penalty-scale clause of the sale agreement, Form 202. A separate record of such material will be kept in small sales. A single scale of all classes of timber subject to the penalty will be entered in this record, but separate entries must be carried for each class to which a different charge applies. Each set of entries should be given a heading indicating the charge applicable. The following may occur:

Material not previously scaled, to be charged for at double the stumpage rate.

Material not previously scaled, to be charged for at the regular, or single, stumpage rate.

In exceptional cases, material previously scaled, to be charged for at double rates.

The original log numbers of material in the latter class will be recorded in the penalty-scale record, the heading indicating that the regular stumpage prices have already been charged.

The record of penalty scale for overrunning trimming allowance under the scaling-length of Form 202 should be noted on the original scale sheets against the number of each log concerned.

Check of Scale Books.

All additions and computations in scale books, including figures read from tables, will be checked either in the supervisor's or regional office as the regional forester may direct. If errors are found, the necessary corrections will be entered on Form 820, supplementing the last scale report of record in the sale.

Cutting Reports.

The forest officer in charge will notify the supervisor when cutting begins on any supervisor's or larger sale. The scale in all such sales will be reported to the supervisor on Form 820 or Form 820a and a duplicate retained in the ranger's files; and the cutting reports will be submitted while work is in progress, covering periods of 1, 2, 3, or 4 weeks, as may be required by the supervisor, but ordinarily ending on Saturday. On forests where a number of sales are in operation dates may be set upon which all cutting reports shall be submitted. So far as practicable the wishes and needs of purchasers should be met in fixing dates for the submission of reports.

In ranger's sales only the final report need be submitted to the supervisor, usually on Form 202c.

In reporting timber cut from sales involving tripartite land exchanges, all material cut, including that to be used for exchange, will be reported in the usual way and Form 820 will show the total amount of money deposited by the purchaser regardless of whether deposits were for timber-sale stumpage or as special credits for land exchange. A separate cutting report Form 820 will be prepared including only the logs designated in the scale book as scaled to satisfy the land-exchange credit. The amount shown under "Deposits" should be the sum total of all credits deposited to cover the cost of land which the Government has acquired. These cutting reports will be numbered beginning as "L-1." Many exchanges are so small that but one cutting report will be needed for each case. On the front of this special cutting report should appear the case designation of the timber sale and beneath this the designation of the land-exchange case. On the back of the form should appear a notation substantially as follows:

This report covers the scale of logs numbered — to —, inclusive, as shown on pages — to —, in scale book number — in the timber sale designated —.

If this report covers all the timber to be cut on a particular exchange, the notation should say so. It should be observed that this special cutting report duplicates timber that has already been reported on the regular timber-sale cutting report (Form 820). The officer making out the report will prepare the special Form 820 in quadruplicate, furnishing three copies to the supervisor, of which two copies must be signed by both reporting and approving officers, and one copy forwarded by the supervisor to the regional office.

Penalty-Scale Reports.

Reports of penalty scale should be made separately from those of the regular scale, preferably by using a properly labeled set of spaces below those giving the regular scale, on the face of Form 820 or Form 820a. If a penalty scale has been made previously but there is none for the period covered by a new cutting report, it will be sufficient to carry forward only the totals of the previous penalty scales, combining all species, and thus only one space on Form 820 will be needed. The circumstances of the penalty scale should be fully explained under "Remarks," or by separate letter to the supervisor, for periods during which a penalty scale has been made.

Check and Record of Cutting Reports.

As cutting reports (Form 820) are received, they should be compared with the timber-sales record card for errors in entries brought forward from the last report and for the correctness of the rates. All calculations will be checked and the information regarding the progress of the sale scrutinized. The date of the report, quantity of each class of material cut, reduced to feet, board measure, by approved converting factors, and total value of material cut since the last report and to date will be entered on the record card. The total value of the cut to date will be compared with the total deposits to prevent cutting in excess of payments.

Scale Records for Purchasers.

Upon request, copies or abstracts of cutting reports will be furnished purchasers after approval by the supervisor. If copies of Form 820 are sent, the entries on the back will be omitted. The scale record may, in the discretion of the officer in charge or of the supervisor, be opened to the purchaser at any time, but in order to avoid arguments concerning individual logs it is advisable to furnish purchasers with the total net scale of not less than 100 logs. The merchantable content of individual logs can not always be determined with exactness, and it must be appreciated by purchasers that average figures rather than the scale of individual logs must finally determine the accuracy of the scale.

Reports of the cut by subdivision of a sale area, such as the output of various subcontractors, will not ordinarily be furnished purchasers, but this may be done with the approval of the supervisor if no sacrifice of time that could be used to advantage is involved and if no interference with other duties will result. In no case will the scale of individual logs be copied on forms or in books furnished by the purchaser as is sometimes requested in order to figure the scale by another scale rule.

Report of Timber Cut and Sold.

Reports on Form 949 will be sent to the regional forester by the supervisor monthly or quarterly as may be required by the regional forester. This report will be mailed not later than the 5th of the succeeding month, even if no timber has been cut or sold during the month or quarter covered by the report. It will be compiled from all Forms 615, 202c, and 202d, which will not be placed in the closed records until after the preparation of this report. All timber for which payment is made, whether cut in sales, administrative use, or settlements, or scaled

under the provisions for penalty scale, will be included. The date of approval of the agreement or stipulation will be taken in each case as the date of sale, even though an emergency sale may have been allowed, and the date of receipt of each cutting report will be taken as the date of cutting. All data will be checked before the report is forwarded. Green and dead timber need not be reported separately except as required by the regional forester.

The amount and value of the timber cut and sold, respectively, in sales at cost will be reported separately. The amount cut in exchange cuttings will also be reported separately.

The report should include a statement of the amount of timber previously reported as sold which will not be cut, owing to expirations, cancellations, or modifications of contracts during the period covered by the report provided the total exceeds 500,000 board feet or its equivalent. Timber resold immediately after the expiration or cancellation of a contract (see first paragraph under "When of advantage to the United States or not prejudicial to its interests," p. 104-S National Forest Manual) will not be so reported nor will it be reported as timber sold.

It will not be necessary to include in this statement the "overcut" or "undercut" in sales which were completed during the quarter.

Regional Forester's Quarterly Report.

As soon as practicable after the first of each quarter the regional forester will report to the chief of the Forest Service the amount and value of timber cut and sold separately during the preceding quarter on each forest in the region. Separate tabulation for sales at cost and exchange cuttings should be included. The report should also include a statement of the amount of timber previously reported as sold which will not be cut, owing to expirations, cancellations, or modifications of contracts during the quarter, as reported by supervisors.

Report on Miscellaneous Products.

Sales of miscellaneous forest products not convertible into board feet, such as Christmas trees, naval stores, tanbark, seedlings, etc., and the amounts removed should be reported in the spaces provided in Form 949 and, in the regional forester's report, in a footnote. So far as possible, however, the volumes of all classes of materials should be reduced to thousand feet board measure by the use of the standard converting factors.

APPENDIX

TABLE 1.—Scribner decimal C log rule
6 TO 18 FOOT LOGS

Diameter, inches	Length—feet												
	6	7	8	9	10	11	12	13	14	15	16	17	18
	Contents—board feet in tens												
6.....	0.5	0.5	0.5	0.5	1	1	1	1	1	1	2	2	2
7.....	.5	1	1	1	1	2	2	2	2	2	3	3	3
8.....	1	1	1	1	2	2	2	2	2	2	3	3	3
9.....	1	2	2	2	3	3	3	3	3	3	4	4	4
10.....	2	2	3	3	3	3	3	4	4	5	6	6	6
11.....	2	2	3	3	4	4	4	5	5	6	7	7	8
12.....	3	3	4	4	5	5	6	6	7	7	8	8	9
13.....	4	4	5	5	6	7	7	8	8	9	10	10	11
14.....	4	5	6	6	7	8	9	9	10	11	11	12	13
15.....	5	6	7	8	9	10	11	12	12	13	14	15	16
16.....	6	7	8	9	10	11	12	13	14	15	16	17	18
17.....	7	8	9	10	12	13	14	15	16	17	18	20	21
18.....	8	9	11	12	13	15	16	17	19	20	21	23	24
19.....	9	10	12	13	15	16	18	19	21	22	24	25	27
20.....	11	12	14	16	17	19	21	23	24	26	28	30	31
21.....	12	13	15	17	19	21	23	25	27	28	30	32	34
22.....	13	15	17	19	21	23	25	27	29	31	33	35	38
23.....	14	16	19	21	23	26	28	31	33	35	38	40	42
24.....	15	18	21	23	25	28	30	33	35	38	40	43	45
25.....	17	20	23	26	29	31	34	37	40	43	46	49	52
26.....	19	22	25	28	31	34	37	41	44	47	50	53	56
27.....	21	24	27	31	34	38	41	44	48	51	55	58	62
28.....	22	25	29	33	36	40	44	47	51	54	58	62	65
29.....	23	27	31	35	38	42	46	49	53	57	61	65	68
30.....	25	29	33	37	41	45	49	53	57	62	66	70	74
31.....	27	31	36	40	44	49	53	58	62	67	71	75	80
32.....	28	32	37	41	46	51	55	60	64	69	74	78	83
33.....	29	34	39	44	49	54	59	64	69	73	78	83	88
34.....	30	35	40	45	50	55	60	65	70	75	80	85	90
35.....	33	38	44	49	55	60	66	71	77	82	88	93	98
36.....	35	40	46	52	58	63	69	75	81	86	92	98	104
37.....	39	45	51	58	64	71	77	84	90	96	103	109	116
38.....	40	47	54	60	67	73	80	87	93	100	107	113	120
39.....	42	49	56	63	70	77	84	91	98	105	112	119	126
40.....	45	53	60	68	75	83	90	98	105	113	120	128	135

TABLE 1.—Scribner decimal C log rule—Continued

19 TO 32 FOOT LOGS

Diameter, inches	Length—feet													
	19	20	21	22	23	24	25	26	27	28	29	30	31	32
	Contents—board feet in tons													
6.....	2	2	2	3	3	3	3	3	4	4	4	4	5	5
7.....	3	3	3	4	4	4	4	4	5	5	5	5	6	6
8.....	3	3	4	4	4	4	5	5	5	6	6	6	7	7
9.....	4	4	5	5	5	6	6	6	7	7	8	8	9	9
10.....	7	7	7	8	8	9	9	9	10	10	11	11	12	12
11.....	8	8	9	9	10	10	11	11	12	12	13	13	14	14
12.....	9	10	10	11	11	12	12	13	13	14	14	15	15	16
13.....	12	12	13	13	14	15	15	16	16	17	18	18	19	19
14.....	14	14	15	16	16	17	18	19	19	20	21	21	22	23
15.....	17	18	19	20	20	21	22	23	24	25	26	27	28	28
16.....	19	20	21	22	23	24	25	26	27	28	29	30	31	32
17.....	22	23	24	25	27	28	29	30	31	32	33	35	36	37
18.....	25	27	28	29	31	32	33	35	36	37	39	40	41	43
19.....	28	30	31	33	34	36	37	39	40	42	43	45	46	48
20.....	33	35	37	38	40	42	44	45	47	49	51	52	54	56
21.....	36	38	40	42	44	46	47	49	51	53	55	57	59	61
22.....	40	42	44	46	48	50	52	54	56	58	60	63	65	67
23.....	45	47	49	52	54	57	59	61	64	66	68	71	73	75
24.....	48	50	53	55	57	61	63	66	68	71	73	76	78	81
25.....	54	57	60	63	66	69	72	75	77	80	83	86	89	92
26.....	59	62	66	69	73	75	78	82	85	88	91	94	97	100
27.....	65	68	72	75	79	82	86	89	92	96	99	103	106	110
28.....	69	73	76	80	84	87	91	95	98	102	105	109	113	116
29.....	72	76	80	84	88	91	95	99	103	107	110	114	118	122
30.....	78	82	86	90	94	99	103	107	111	115	119	123	127	131
31.....	84	89	93	98	102	106	111	115	120	124	129	133	138	142
32.....	87	92	97	101	106	110	115	120	124	129	133	138	143	147
33.....	98	98	103	108	113	118	122	127	132	137	142	147	152	157
34.....	96	100	105	110	115	120	125	130	135	140	145	150	155	160
35.....	104	109	115	120	126	131	137	142	148	153	159	164	170	175
36.....	110	115	121	127	132	138	144	150	156	161	167	173	179	185
37.....	122	129	135	142	148	154	161	167	174	180	187	193	199	206
38.....	127	133	140	147	153	160	167	174	180	187	193	200	207	214
39.....	133	140	147	154	161	168	175	182	189	196	203	210	217	224
40.....	143	150	158	166	173	181	188	196	203	211	218	226	233	241

TABLE 1.—Scribner decimal C log rule—Continued

6 TO 18 FOOT LOGS—Continued

Diameter, inches	Length—feet												
	6	7	8	9	10	11	12	13	14	15	16	17	18
	Contents—board feet in tens												
41.....	48	56	64	72	79	87	95	103	111	119	127	135	143
42.....	50	59	67	76	84	92	101	109	117	126	134	143	151
43.....	52	61	70	79	87	96	105	113	122	131	140	148	157
44.....	56	65	74	83	93	102	111	120	129	139	148	157	166
45.....	57	66	76	85	95	104	114	123	133	143	152	161	171
46.....	59	69	79	89	99	109	119	129	139	149	159	169	178
47.....	62	72	83	93	104	114	124	134	145	155	166	176	186
48.....	65	76	86	97	108	119	130	140	151	162	173	184	194
49.....	67	79	90	101	112	124	135	146	157	168	180	191	202
50.....	70	82	94	105	117	129	140	152	164	175	187	199	211
51.....	73	85	97	110	122	134	146	158	170	183	195	207	219
52.....	76	89	101	114	127	139	152	165	177	190	202	215	228
53.....	79	92	105	118	132	145	158	171	184	197	210	224	237
54.....	82	96	109	123	137	150	164	177	191	205	218	232	246
55.....	85	99	113	127	142	156	170	184	198	212	227	241	255
56.....	88	103	118	132	147	162	176	191	206	220	235	250	264
57.....	91	107	122	137	152	167	183	198	213	228	244	259	274
58.....	95	110	126	142	158	174	189	205	221	237	252	268	284
59.....	98	114	131	147	163	180	196	212	229	245	261	278	294
60.....	101	118	135	152	169	186	203	220	237	253	270	287	304
61.....	105	123	140	158	175	193	210	228	245	263	280	298	315
62.....	108	127	145	163	181	199	217	235	253	271	289	307	325
63.....	112	131	149	168	187	205	224	243	261	280	299	317	336
64.....	116	135	154	174	193	213	232	251	270	290	309	329	348
65.....	119	139	159	179	199	219	239	259	279	299	319	339	358
66.....	123	144	164	185	206	226	247	268	288	309	329	350	370
67.....	127	148	170	191	212	233	254	275	297	318	339	360	381
68.....	131	153	175	197	219	240	262	284	306	328	350	371	393
69.....	135	158	180	203	226	248	271	294	316	339	361	384	406
70.....	139	163	186	209	232	256	279	302	325	349	372	395	419
71.....	144	167	192	215	240	263	287	311	335	359	383	407	430
72.....	148	173	197	222	247	271	296	321	345	370	395	419	444
73.....	152	178	203	229	254	280	305	330	356	381	406	432	457
74.....	157	183	209	236	261	288	314	340	366	393	418	445	471
75.....	161	188	215	242	269	296	323	350	377	404	430	458	484
76.....	166	194	221	249	277	304	332	360	387	415	443	470	498
77.....	171	199	228	256	285	313	341	369	398	426	455	483	511
78.....	176	205	234	263	293	322	351	380	410	439	468	497	527
79.....	180	211	240	271	301	331	361	391	421	451	481	511	541
80.....	185	216	247	278	309	340	371	402	432	464	494	526	556

TABLE 1.—Scribner decimal C log rule—Continued
19 TO 32 FOOT LOGS—Continued

Diameter, inches	Length—feet													
	19	20	21	22	23	24	25	26	27	28	29	30	31	32
	Contents—board feet in tens													
41.....	151	159	167	175	183	191	199	207	215	223	230	238	246	254
42.....	159	168	176	185	193	201	210	218	227	235	243	252	260	269
43.....	166	174	183	192	200	209	218	227	236	244	253	262	270	279
44.....	176	185	194	204	213	222	231	241	250	259	268	278	287	296
45.....	180	190	199	209	218	228	237	247	256	266	275	286	294	304
46.....	188	198	208	218	228	238	248	258	268	278	288	297	307	317
47.....	197	207	217	228	238	248	259	269	279	290	300	310	321	331
48.....	205	216	227	238	248	260	270	281	292	302	313	324	335	346
49.....	213	225	236	247	258	270	281	292	303	314	326	337	348	359
50.....	222	234	246	257	269	281	292	304	316	328	339	351	363	374
51.....	231	243	256	268	280	292	304	315	329	341	353	365	377	389
52.....	241	253	266	278	291	304	316	329	342	354	367	380	392	405
53.....	250	263	276	289	302	316	329	341	355	368	381	395	408	421
54.....	259	273	287	300	314	328	341	355	369	382	396	410	423	437
55.....	269	283	297	312	326	340	354	368	382	397	411	425	439	453
56.....	279	294	309	323	338	353	367	382	397	411	426	441	455	470
57.....	289	304	320	335	350	365	381	396	411	426	442	457	472	487
58.....	300	315	331	347	363	379	394	410	426	442	457	473	489	505
59.....	310	327	343	359	376	392	408	425	441	457	474	490	506	523
60.....	321	338	355	372	389	406	422	439	456	473	490	507	524	541
61.....	332	350	368	385	403	420	438	455	473	490	508	525	543	560
62.....	344	362	380	398	416	434	452	470	488	506	524	542	561	579
63.....	355	373	392	411	429	448	467	485	504	523	541	560	579	597
64.....	367	387	406	425	445	464	483	503	522	541	561	580	599	619
65.....	378	398	418	438	458	478	498	518	538	558	578	597	617	637
66.....	391	412	432	453	473	494	515	535	556	576	597	617	638	659
67.....	402	423	445	466	487	508	529	550	572	593	614	635	656	677
68.....	415	437	459	480	502	524	546	568	590	611	633	655	677	699
69.....	429	452	474	497	519	542	565	587	610	632	655	677	700	723
70.....	442	465	488	512	535	558	581	605	628	651	674	698	721	744
71.....	454	478	502	526	550	574	598	622	646	670	694	717	741	765
72.....	469	493	518	543	567	592	617	641	666	691	715	740	765	789
73.....	483	508	534	559	585	610	635	661	686	712	737	762	788	813
74.....	497	523	550	576	602	628	654	680	707	733	759	785	811	837
75.....	511	538	565	592	619	646	673	700	727	754	781	807	834	861
76.....	526	553	581	609	636	664	692	719	747	775	802	830	858	885
77.....	540	568	597	625	654	682	710	739	767	796	824	852	881	909
78.....	556	585	614	644	673	702	731	761	790	819	848	878	907	936
79.....	572	602	632	662	692	722	752	782	812	842	872	902	933	963
80.....	587	618	649	680	711	742	773	804	835	866	897	927	958	989

TABLE 1.—Scribner decimal C log rule—Continued

6 TO 18 FOOT LOGS—Continued

Diameter, inches	Length—feet												
	6	7	8	9	10	11	12	13	14	15	16	17	18
	Contents—board feet in tons												
<i>Ins.</i>													
81.....	190	222	254	286	317	349	381	413	444	476	508	540	572
82.....	196	228	261	293	326	358	391	424	456	489	521	554	586
83.....	201	234	268	301	335	368	401	434	468	501	535	568	601
84.....	206	240	275	309	343	378	412	446	481	515	549	584	618
85.....	210	246	281	316	351	386	421	456	491	526	561	596	631
86.....	215	251	287	323	359	395	431	467	503	539	575	611	646
87.....	221	258	295	332	368	405	442	479	516	553	589	626	663
88.....	226	264	301	339	377	414	452	490	527	565	603	640	678
89.....	231	270	308	347	385	424	462	501	539	578	616	655	693
90.....	236	275	315	354	393	433	472	511	551	590	629	669	708
91.....	241	282	322	362	402	443	483	523	563	604	644	684	725
92.....	246	288	329	370	411	452	493	534	575	616	657	698	740
93.....	251	293	335	377	419	461	503	545	587	629	671	713	755
94.....	257	300	343	386	428	471	514	557	600	643	685	728	771
95.....	262	306	350	394	437	481	525	569	612	656	700	744	788
96.....	268	313	357	402	446	491	536	581	625	670	715	759	804
97.....	273	319	364	410	455	501	546	592	637	683	728	774	819
98.....	278	325	371	418	464	511	557	603	650	696	743	789	836
99.....	284	331	379	426	473	521	568	615	663	710	757	805	852
100.....	289	338	386	434	482	531	579	627	675	724	772	820	869
101.....	295	344	393	443	492	541	590	639	688	738	787	836	885
102.....	301	351	401	452	502	552	602	652	702	753	803	853	903
103.....	307	358	409	461	512	563	614	665	716	768	819	870	921
104.....	313	365	417	470	522	574	626	678	730	783	835	887	939
105.....	319	372	425	479	532	585	638	691	744	798	851	904	957
106.....	325	379	433	488	542	596	650	704	758	813	867	921	975
107.....	331	387	442	497	553	608	663	718	773	829	884	939	995
108.....	337	394	450	506	563	619	675	731	788	844	900	956	1,013
109.....	344	401	459	516	573	631	688	745	803	860	917	975	1,032
110.....	350	408	467	525	583	642	700	758	817	875	933	992	1,050
111.....	356	416	475	535	594	654	713	772	832	891	951	1,010	1,070
112.....	362	423	483	544	604	665	725	785	846	906	967	1,027	1,088
113.....	369	431	492	554	615	677	738	800	861	923	984	1,046	1,107
114.....	375	438	501	563	626	688	751	814	876	939	1,001	1,064	1,127
115.....	382	446	509	573	637	700	764	828	891	955	1,019	1,082	1,146
116.....	389	454	519	584	648	713	778	843	908	973	1,037	1,102	1,167
117.....	396	462	528	594	660	726	792	858	924	990	1,056	1,122	1,188
118.....	403	470	537	605	672	739	806	873	940	1,008	1,075	1,142	1,209
119.....	410	478	547	615	683	752	820	888	957	1,025	1,093	1,162	1,230
120.....	417	487	556	626	695	765	834	904	973	1,043	1,112	1,182	1,251

TABLE 1.—Scribner decimal C log rule—Continued

19 TO 32 FOOT LOGS—Continued

Diameter, inches	Length—feet													
	19	20	21	22	23	24	25	26	27	28	29	30	31	32
	Contents—board feet in tens													
81	603	635	667	699	730	762	794	826	857	889	921	953	984	1,016
82	619	652	684	717	749	782	815	847	880	912	945	977	1,010	1,043
83	635	668	702	735	769	802	835	869	902	936	969	1,002	1,036	1,069
84	652	687	721	755	790	824	858	893	927	961	996	1,030	1,064	1,099
85	667	702	737	772	807	842	877	912	947	982	1,017	1,052	1,088	1,123
86	682	718	754	790	826	862	898	934	970	1,006	1,042	1,077	1,113	1,149
87	700	737	774	810	847	884	921	958	995	1,031	1,068	1,105	1,142	1,179
88	716	753	791	829	866	904	942	979	1,017	1,055	1,092	1,130	1,168	1,205
89	732	770	809	847	886	924	963	1,001	1,040	1,078	1,117	1,155	1,194	1,232
90	747	787	826	865	905	944	983	1,023	1,062	1,101	1,141	1,180	1,219	1,259
91	765	805	845	886	926	966	1,006	1,047	1,087	1,127	1,167	1,208	1,248	1,288
92	781	822	863	904	945	986	1,027	1,068	1,109	1,150	1,191	1,233	1,274	1,315
93	796	838	880	922	964	1,006	1,048	1,090	1,132	1,174	1,216	1,258	1,299	1,341
94	814	857	900	942	985	1,028	1,071	1,114	1,157	1,199	1,242	1,285	1,328	1,371
95	831	875	919	963	1,006	1,050	1,094	1,138	1,181	1,225	1,269	1,313	1,356	1,400
96	849	893	938	983	1,027	1,072	1,117	1,161	1,206	1,251	1,295	1,340	1,385	1,429
97	865	910	956	1,001	1,047	1,092	1,138	1,183	1,229	1,274	1,320	1,365	1,411	1,456
98	882	928	975	1,021	1,068	1,114	1,160	1,207	1,253	1,300	1,346	1,392	1,439	1,485
99	899	947	994	1,041	1,089	1,136	1,183	1,231	1,278	1,325	1,373	1,420	1,467	1,515
100	917	965	1,013	1,062	1,110	1,158	1,206	1,255	1,303	1,351	1,399	1,448	1,496	1,544
101	934	983	1,033	1,082	1,131	1,180	1,229	1,278	1,328	1,377	1,426	1,475	1,524	1,573
102	953	1,003	1,054	1,104	1,154	1,204	1,254	1,304	1,355	1,405	1,455	1,505	1,555	1,605
103	972	1,023	1,075	1,126	1,177	1,228	1,279	1,330	1,382	1,433	1,484	1,535	1,586	1,637
104	991	1,043	1,096	1,148	1,200	1,252	1,304	1,356	1,409	1,461	1,513	1,565	1,617	1,669
105	1,010	1,063	1,117	1,170	1,223	1,276	1,329	1,382	1,436	1,489	1,542	1,595	1,648	1,701
106	1,029	1,083	1,138	1,192	1,246	1,300	1,354	1,408	1,463	1,517	1,571	1,625	1,679	1,733
107	1,050	1,105	1,160	1,216	1,271	1,326	1,381	1,437	1,492	1,547	1,602	1,658	1,713	1,768
108	1,069	1,125	1,181	1,238	1,294	1,350	1,406	1,463	1,519	1,575	1,631	1,688	1,744	1,800
109	1,089	1,147	1,204	1,261	1,319	1,376	1,433	1,491	1,548	1,605	1,663	1,720	1,777	1,835
110	1,108	1,167	1,225	1,283	1,342	1,400	1,458	1,517	1,575	1,633	1,692	1,750	1,808	1,867
111	1,129	1,188	1,248	1,307	1,367	1,426	1,485	1,545	1,604	1,664	1,723	1,783	1,842	1,901
112	1,148	1,208	1,269	1,329	1,390	1,450	1,510	1,571	1,631	1,692	1,752	1,813	1,873	1,933
113	1,169	1,230	1,292	1,353	1,415	1,476	1,538	1,599	1,661	1,722	1,784	1,845	1,907	1,968
114	1,189	1,252	1,314	1,377	1,439	1,502	1,565	1,627	1,690	1,752	1,815	1,878	1,940	2,003
115	1,210	1,273	1,337	1,401	1,464	1,528	1,592	1,655	1,719	1,783	1,846	1,910	1,974	2,037
116	1,232	1,297	1,362	1,426	1,491	1,556	1,621	1,686	1,751	1,815	1,880	1,945	2,010	2,075
117	1,254	1,320	1,386	1,452	1,518	1,584	1,650	1,716	1,782	1,848	1,914	1,980	2,046	2,112
118	1,276	1,343	1,411	1,478	1,545	1,612	1,679	1,746	1,814	1,881	1,948	2,015	2,082	2,149
119	1,298	1,367	1,435	1,503	1,572	1,640	1,708	1,777	1,845	1,913	1,982	2,050	2,118	2,187
120	1,321	1,390	1,460	1,529	1,599	1,668	1,738	1,807	1,877	1,946	2,016	2,085	2,155	2,224

TABLE 1.—Scribner decimal C log rule—Continued

34 TO 40 FOOT LOGS

Diameter (inches)	Length—feet				Diameter (inches)	Length—feet			
	34	36	38	40		34	36	38	40
	Contents—board feet in tons					Contents—board feet in tons			
6.....	5	6	6	7	46.....	338	356	376	396
7.....	6	6	6	7	47.....	352	372	394	414
8.....	7	8	8	9	48.....	368	388	410	432
9.....	10	10	11	12	49.....	382	404	427	449
10.....	13	14	14	15	50.....	398	421	445	468
11.....	15	16	17	18	51.....	414	438	462	487
12.....	17	18	19	20	52.....	430	455	481	506
13.....	21	22	23	24	53.....	447	473	500	526
14.....	24	26	27	29	54.....	464	491	519	546
15.....	30	32	34	36	55.....	481	510	538	566
16.....	34	36	38	40	56.....	500	529	558	588
17.....	39	42	44	46	57.....	518	548	578	609
18.....	45	48	51	53	58.....	536	568	599	631
19.....	51	54	57	60	59.....	555	588	620	653
20.....	60	63	66	70	60.....	575	608	642	676
21.....	65	68	72	76	61.....	594	629	664	699
22.....	71	75	79	84	62.....	614	650	687	723
23.....	80	85	89	94	63.....	635	672	710	746
24.....	86	91	96	101	64.....	656	694	733	772
25.....	98	103	109	115	65.....	677	717	757	796
26.....	106	112	119	125	66.....	699	740	781	822
27.....	116	123	130	137	67.....	721	763	806	848
28.....	124	131	138	146	68.....	744	787	831	875
29.....	129	137	145	152	69.....	767	812	857	902
30.....	140	148	156	164	70.....	790	837	883	930
31.....	151	160	169	178	71.....	814	862	910	958
32.....	156	166	175	184	72.....	838	888	937	986
33.....	167	176	186	196	73.....	864	914	965	1,016
34.....	170	180	190	200	74.....	889	941	993	1,046
35.....	186	197	208	219	75.....	915	968	1,022	1,076
36.....	196	208	219	230	76.....	941	996	1,051	1,107
37.....	218	232	244	258	77.....	967	1,024	1,081	1,138
38.....	226	240	254	266	78.....	994	1,053	1,112	1,170
39.....	238	252	266	280	79.....	1,022	1,082	1,142	1,202
40.....	256	270	286	300	80.....	1,050	1,112	1,174	1,236
41.....	270	286	302	318	81.....	1,078	1,142	1,205	1,269
42.....	286	302	318	336	82.....	1,108	1,173	1,238	1,303
43.....	296	314	332	348	83.....	1,137	1,202	1,271	1,338
44.....	314	332	352	370	84.....	1,167	1,236	1,305	1,373
45.....	322	342	360	380	85.....	1,192	1,262	1,334	1,404

TABLE 1.—Scribner decimal C log rule—Continued

24 TO 40 FOOT LOGS

Diameter (inches)	Length—feet				Diameter (inches)	Length—feet			
	34	36	38	40		34	36	38	40
	Contents—board feet in tons					Contents—board feet in tons			
86.....	1, 222	1, 292	1, 364	1, 436	103.....	1, 740	1, 842	1, 944	2, 046
87.....	1, 252	1, 326	1, 400	1, 474	104.....	1, 774	1, 878	1, 982	2, 086
88.....	1, 280	1, 356	1, 432	1, 506	105.....	1, 808	1, 914	2, 020	2, 126
89.....	1, 310	1, 386	1, 464	1, 540	106.....	1, 842	1, 950	2, 068	2, 166
					107.....	1, 878	1, 990	2, 100	2, 210
90.....	1, 338	1, 416	1, 494	1, 574	108.....	1, 912	2, 026	2, 138	2, 250
91.....	1, 368	1, 450	1, 530	1, 610	109.....	1, 950	2, 064	2, 178	2, 294
92.....	1, 396	1, 480	1, 562	1, 644					
93.....	1, 426	1, 510	1, 592	1, 676	110.....	1, 984	2, 100	2, 216	2, 334
94.....	1, 456	1, 542	1, 628	1, 714	111.....	2, 020	2, 140	2, 258	2, 376
95.....	1, 488	1, 576	1, 662	1, 750	112.....	2, 054	2, 176	2, 296	2, 416
96.....	1, 518	1, 608	1, 698	1, 786	113.....	2, 092	2, 214	2, 338	2, 460
97.....	1, 548	1, 638	1, 730	1, 820	114.....	2, 128	2, 254	2, 378	2, 504
98.....	1, 578	1, 672	1, 764	1, 856	115.....	2, 164	2, 292	2, 420	2, 546
99.....	1, 610	1, 704	1, 798	1, 894	116.....	2, 204	2, 334	2, 464	2, 594
					117.....	2, 244	2, 376	2, 508	2, 640
100.....	1, 640	1, 738	1, 834	1, 930	118.....	2, 284	2, 418	2, 552	2, 686
101.....	1, 672	1, 770	1, 868	1, 966	119.....	2, 324	2, 460	2, 596	2, 734
102.....	1, 706	1, 806	1, 906	2, 006	120.....	2, 364	2, 502	2, 642	2, 780

TABLE 2.—*Deduction for rectangular defects*
 [20 per cent deducted for kerf from solid board-foot contents]

End dimensions, inches	Length of defect—feet																		
	4	5	6	7	8	9	10	11	12	13	14	15	16	17	18	19	20		
	Contents—board feet in tens																		
2 x 3				0.5	0.5	0.5	0.5	0.5	0.5	0.5	0.5	0.5	0.5	0.5	0.5	0.5	0.5	0.5	1
4		0.5	0.5	.5	.5	.5	.5	.5	.5	.5	.5	.5	.5	.5	.5	.5	.5	.5	1
5	0.5	.4	.5	.5	.5	.5	.5	.5	1	1	1	1	1	1	1	1	1	1	1
6	.5	.5	.5	.5	.5	.5	.5	1	1	1	1	1	1	1	1	1	1	1	1
7	.5	.5	.5	.5	.5	.5	1	1	1	1	1	1	1	1	1	1	1	1	1
3 x 4	.5	.5	.5	.5	.5	.5	1	1	1	1	1	1	1	1	1	1	1	1	1
5	.5	.5	.5	.5	1	1	1	1	1	1	1	1	1	1	1	1	1	1	1
6	.5	.5	.5	.5	1	1	1	1	1	1	1	1	1	1	1	1	1	1	1
7	.5	.5	1	1	1	1	1	1	1	1	1	1	1	1	1	1	1	1	1
8	.5	1	1	1	1	1	1	1	1	1	1	1	1	1	1	1	1	1	1
9	1	1	1	1	1	1	1	1	1	1	1	1	1	1	1	1	1	1	1
10	1	1	1	1	1	1	1	1	1	1	1	1	1	1	1	1	1	1	1
11	1	1	1	1	1	1	1	1	1	1	1	1	1	1	1	1	1	1	1
4 x 5	.5	.5	1	1	1	1	1	1	1	1	1	1	1	1	1	1	1	1	1
6	1	1	1	1	1	1	1	1	1	1	1	1	1	1	1	1	1	1	1
7	1	1	1	1	1	1	1	1	1	1	1	1	1	1	1	1	1	1	1
8	1	1	1	1	1	1	1	1	1	1	1	1	1	1	1	1	1	1	1
9	1	1	1	1	1	1	1	1	1	1	1	1	1	1	1	1	1	1	1
10	1	1	1	1	1	1	1	1	1	1	1	1	1	1	1	1	1	1	1
11	1	1	1	1	1	1	1	1	1	1	1	1	1	1	1	1	1	1	1
12	1	1	1	1	1	1	1	1	1	1	1	1	1	1	1	1	1	1	1
13	1	1	1	1	1	1	1	1	1	1	1	1	1	1	1	1	1	1	1
5 x 6	1	1	1	1	1	1	1	1	1	1	1	1	1	1	1	1	1	1	1
7	1	1	1	1	1	1	1	1	1	1	1	1	1	1	1	1	1	1	1
8	1	1	1	1	1	1	1	1	1	1	1	1	1	1	1	1	1	1	1
9	1	1	1	1	1	1	1	1	1	1	1	1	1	1	1	1	1	1	1
10	1	1	1	1	1	1	1	1	1	1	1	1	1	1	1	1	1	1	1
11	1	1	1	1	1	1	1	1	1	1	1	1	1	1	1	1	1	1	1
12	1	1	1	1	1	1	1	1	1	1	1	1	1	1	1	1	1	1	1
13	1	1	1	1	1	1	1	1	1	1	1	1	1	1	1	1	1	1	1
14	1	1	1	1	1	1	1	1	1	1	1	1	1	1	1	1	1	1	1
15	1	1	1	1	1	1	1	1	1	1	1	1	1	1	1	1	1	1	1
16	1	1	1	1	1	1	1	1	1	1	1	1	1	1	1	1	1	1	1
6 x 7	1	1	1	1	1	1	1	1	1	1	1	1	1	1	1	1	1	1	1
8	1	1	1	1	1	1	1	1	1	1	1	1	1	1	1	1	1	1	1
9	1	1	1	1	1	1	1	1	1	1	1	1	1	1	1	1	1	1	1
10	1	1	1	1	1	1	1	1	1	1	1	1	1	1	1	1	1	1	1
11	1	1	1	1	1	1	1	1	1	1	1	1	1	1	1	1	1	1	1
12	1	1	1	1	1	1	1	1	1	1	1	1	1	1	1	1	1	1	1
13	1	1	1	1	1	1	1	1	1	1	1	1	1	1	1	1	1	1	1
14	1	1	1	1	1	1	1	1	1	1	1	1	1	1	1	1	1	1	1
15	1	1	1	1	1	1	1	1	1	1	1	1	1	1	1	1	1	1	1
16	1	1	1	1	1	1	1	1	1	1	1	1	1	1	1	1	1	1	1
17	1	1	1	1	1	1	1	1	1	1	1	1	1	1	1	1	1	1	1
18	1	1	1	1	1	1	1	1	1	1	1	1	1	1	1	1	1	1	1
19	1	1	1	1	1	1	1	1	1	1	1	1	1	1	1	1	1	1	1
20	1	1	1	1	1	1	1	1	1	1	1	1	1	1	1	1	1	1	1
21	1	1	1	1	1	1	1	1	1	1	1	1	1	1	1	1	1	1	1
22	1	1	1	1	1	1	1	1	1	1	1	1	1	1	1	1	1	1	1

TABLE 2.—Deduction for rectangular defects—Continued

End dimensions, inches	Length of defect—feet																	
	21	22	23	24	25	26	27	28	29	30	31	32	34	36	38	40		
	Contents—board feet in tens																	
2 x 3.....	1	1	1	1	1	1	1	1	1	1	1	1	1	1	1	1	1	
4.....	1	1	1	1	1	1	1	1	1	2	2	2	2	2	2	2	2	
5.....	1	1	2	2	2	2	2	2	2	2	2	2	2	2	2	2	2	
6.....	2	2	2	2	2	2	2	2	2	2	2	2	2	2	2	2	2	
7.....	2	2	2	2	2	2	2	3	3	3	3	3	3	3	3	3	3	
3 x 4.....	2	2	2	2	2	2	2	2	2	2	2	2	3	3	3	3	3	
5.....	2	2	2	2	2	2	3	3	3	3	3	3	3	3	4	4	4	
6.....	3	3	3	3	3	3	3	3	3	3	3	3	3	3	4	4	4	
7.....	3	3	3	3	3	3	4	4	4	4	4	4	4	4	5	5	5	
8.....	3	4	4	4	4	4	4	4	4	5	5	5	5	5	6	6	6	
9.....	4	4	4	4	4	4	4	4	4	5	5	5	5	5	6	6	6	
10.....	4	4	5	5	5	5	5	5	5	6	6	6	6	6	7	7	7	
11.....	5	5	5	5	6	6	6	6	6	6	7	7	7	7	8	8	8	
4 x 5.....	3	3	3	3	3	3	3	4	4	4	4	4	4	5	5	5	5	
6.....	3	4	4	4	4	4	4	4	4	5	5	5	5	5	6	6	6	
7.....	4	4	4	4	5	5	5	5	5	6	6	6	6	6	7	7	7	
8.....	4	5	5	5	5	6	6	6	6	6	7	7	7	7	8	8	8	
9.....	5	5	6	6	6	6	6	7	7	7	7	8	8	8	9	9	9	
10.....	6	6	6	6	7	7	7	7	7	8	8	8	9	9	9	10	10	
11.....	6	6	7	7	7	8	8	8	8	9	9	9	9	10	10	11	11	
12.....	7	7	7	8	8	8	8	9	9	9	10	10	10	10	11	11	12	
13.....	7	8	8	8	9	9	9	9	10	10	10	11	11	11	12	12	13	
5 x 6.....	4	4	5	5	5	5	5	6	6	6	6	6	7	7	7	8	8	
7.....	5	5	5	6	6	6	6	6	7	7	7	7	7	8	8	9	9	
8.....	6	6	6	6	7	7	7	7	8	8	8	8	9	9	10	10	11	
9.....	6	7	7	7	8	8	8	8	8	9	9	9	10	10	11	11	12	
10.....	7	7	8	8	8	9	9	9	10	10	10	11	11	11	12	12	13	
11.....	8	8	8	9	9	10	10	10	10	11	11	11	12	12	12	13	14	
12.....	8	9	9	10	10	10	10	11	11	12	12	12	13	13	14	14	15	
13.....	9	10	10	10	11	11	12	12	12	13	13	13	14	14	15	16	16	
14.....	10	10	11	11	12	12	12	13	13	14	14	14	15	15	16	17	18	
15.....	10	11	12	12	12	13	13	14	14	14	15	15	16	16	17	18	19	
16.....	11	12	12	13	13	14	14	15	15	16	16	17	17	18	19	20	21	
6 x 7.....	6	6	6	7	7	7	8	8	8	8	9	9	10	10	10	11	11	
8.....	7	7	7	8	8	8	8	9	9	9	10	10	10	10	11	12	12	
9.....	8	8	8	9	9	9	10	10	10	10	11	11	12	12	13	14	14	
10.....	8	9	9	10	10	10	10	11	11	12	12	12	13	14	14	15	16	
11.....	9	10	10	11	11	11	12	12	13	13	13	14	14	15	16	17	18	
12.....	10	11	11	12	12	12	13	13	13	14	14	15	15	16	17	18	19	
13.....	11	11	12	12	13	13	14	14	15	15	16	16	17	18	19	20	21	
14.....	12	12	13	13	14	14	15	15	16	16	17	17	18	19	20	21	22	
15.....	13	13	14	14	15	15	16	16	17	17	18	18	19	20	22	23	24	
16.....	13	14	15	15	16	17	17	18	18	19	19	20	20	22	23	24	26	
17.....	14	15	16	16	17	18	18	19	20	20	21	22	23	24	26	27	27	
18.....	15	16	17	17	18	19	19	20	21	22	22	23	24	26	27	29	29	
19.....	16	17	17	18	19	20	21	21	22	23	24	24	26	27	29	30	30	
20.....	17	18	18	19	20	21	22	22	23	24	25	26	27	29	30	32	32	
21.....	18	18	19	20	21	22	23	24	24	25	26	27	29	30	32	34	34	
22.....	18	19	20	21	22	23	24	25	26	26	27	28	30	32	33	35	35	

TABLE 2.—Deduction for rectangular defects—Continued

End dimensions, inches	Length of defect—feet																		
	4	5	6	7	8	9	10'	11	12	13	14	15	16	17	18	19	20		
	Contents—board feet in tens																		
7 x 8----	1	2	2	3	3	3	4	4	4	5	5	6	6	6	7	7	7	7	
9----	2	2	3	3	3	4	4	5	5	5	6	6	6	7	7	8	8	8	
10----	2	3	3	3	4	4	5	5	6	6	7	7	8	8	9	10	10	11	
11----	2	3	3	4	4	5	5	6	6	7	7	8	8	9	9	10	10	11	
12----	2	3	3	4	4	5	5	6	6	7	7	8	8	9	10	10	11	11	
13----	2	3	4	4	5	5	6	7	7	8	8	9	10	10	11	12	12	12	
14----	3	3	4	5	5	6	7	7	8	8	9	10	10	11	12	12	13	13	
15----	3	4	4	5	6	6	7	8	8	9	10	10	11	12	13	13	14	14	
16----	3	4	4	5	6	7	7	8	9	10	10	11	12	13	13	14	15	15	
17----	3	4	5	6	6	7	8	9	10	10	11	12	13	13	14	15	16	16	
18----	3	4	5	6	7	8	8	9	10	11	12	13	13	14	15	16	17	17	
19----	4	4	5	6	7	8	9	10	11	12	12	13	14	15	16	17	18	18	
20----	4	5	6	7	7	8	9	10	11	12	13	14	15	16	17	18	19	19	
21----	4	5	6	7	8	9	10	11	12	13	14	15	16	17	18	19	20	20	
22----	4	5	6	7	8	9	10	11	12	13	14	15	16	17	18	20	21	21	
23----	4	5	6	8	9	10	11	12	13	14	15	16	17	18	19	20	21	22	
24----	4	6	7	8	9	10	11	12	13	15	16	17	18	19	20	21	22	22	
8 x 9----	2	2	3	3	4	4	5	5	6	6	7	7	8	8	9	10	10	11	
10----	2	3	3	4	4	5	5	6	6	7	7	8	9	9	10	10	11	11	
11----	2	3	4	4	5	5	6	6	7	8	8	9	9	10	11	11	12	12	
12----	3	3	4	4	5	6	6	7	8	8	9	10	10	11	12	12	13	13	
13----	3	3	4	5	6	6	7	8	8	9	10	10	11	12	13	14	14	15	
14----	3	4	4	5	6	7	8	9	10	10	11	12	13	14	15	16	17	17	
15----	3	4	5	6	6	7	8	9	10	10	11	12	13	14	15	16	17	18	
16----	3	4	5	6	7	8	9	9	10	11	12	13	14	15	16	17	18	18	
17----	4	5	5	6	7	8	9	10	11	12	13	14	15	16	17	18	19	19	
18----	4	5	6	7	8	9	10	11	12	12	13	14	15	16	17	18	19	20	
19----	4	5	6	7	8	9	10	11	12	13	14	15	16	17	18	19	20	21	
20----	4	5	6	7	9	10	11	12	13	14	15	16	17	18	19	20	21	22	
21----	4	6	7	8	9	10	11	12	13	15	16	17	18	19	20	21	22	22	
22----	5	6	7	8	9	11	12	13	14	15	16	18	19	20	21	22	23	23	
23----	5	6	7	9	10	11	12	13	15	16	17	18	20	21	22	23	24	25	
24----	5	6	8	9	10	12	13	14	15	17	18	19	20	22	23	24	26	26	
25----	5	7	8	9	11	12	13	15	16	17	19	20	21	23	24	25	27	27	
26----	6	7	8	10	11	12	14	15	17	18	19	21	22	24	25	26	28	28	
27----	6	7	9	10	12	13	14	16	17	19	20	22	23	24	26	27	29	29	
28----	6	7	9	10	12	13	15	16	18	19	21	22	24	25	27	28	30	30	
29----	6	8	9	11	12	14	15	17	19	20	22	23	25	26	28	29	31	31	
30----	6	8	10	11	13	14	16	18	19	21	22	24	26	27	29	30	32	32	

TABLE 2.—Deduction for rectangular defects—Continued

End dimensions, inches	Length of defects—feet																
	21	22	23	24	25	26	27	28	29	30	31	32	34	35	38	40	
	Contents—board feet in tons																
7 x 8.....	8	8	9	9	9	10	10	10	11	11	11	12	12	13	13	14	15
9.....	9	9	10	10	10	11	11	11	12	12	13	13	14	14	15	16	17
10.....	10	10	11	11	12	12	13	13	14	14	15	15	16	16	17	18	19
11.....	11	11	12	12	13	13	14	14	15	15	16	16	17	17	18	20	21
12.....	12	12	13	13	14	15	15	16	16	17	17	18	18	19	20	21	22
13.....	13	13	14	15	15	16	16	17	18	18	19	19	20	21	22	23	24
14.....	14	14	15	16	16	17	18	18	19	20	20	21	22	22	24	25	26
15.....	15	15	16	17	18	18	19	20	20	21	22	22	24	25	27	28	30
16.....	16	16	17	18	19	19	20	21	22	22	23	24	25	27	28	30	32
17.....	17	17	18	19	20	21	21	22	23	24	25	25	27	29	29	30	32
18.....	18	18	19	20	21	22	23	24	25	26	27	28	29	30	32	34	35
19.....	19	20	20	21	22	23	24	25	26	27	27	28	30	32	34	35	37
20.....	20	21	21	22	23	24	25	26	27	28	29	30	32	34	35	37	39
21.....	21	22	23	24	25	26	27	28	29	30	31	32	33	35	37	39	41
22.....	22	23	24	25	26	27	28	29	30	31	32	33	35	37	39	41	43
23.....	23	24	25	26	27	28	29	30	31	32	33	34	36	39	41	43	45
24.....	24	25	26	27	28	29	30	31	32	34	35	36	38	40	43	45	
8 x 9.....	10	11	11	12	12	13	13	13	14	14	15	15	16	17	18	19	20
10.....	11	12	12	13	13	14	14	15	15	16	17	17	18	19	20	21	22
11.....	12	13	13	14	15	15	16	16	17	18	18	19	20	21	22	23	24
12.....	13	14	15	15	16	17	17	18	19	19	20	20	22	23	24	26	28
13.....	15	15	16	17	17	18	19	19	20	21	21	22	24	25	26	28	30
14.....	16	16	17	18	19	19	20	21	22	22	23	24	25	27	28	30	32
15.....	17	18	18	19	20	21	22	22	23	24	25	26	27	29	30	32	34
16.....	18	19	20	20	21	22	23	24	25	26	26	27	29	31	32	34	36
17.....	19	20	21	22	23	24	24	25	26	27	28	29	31	33	34	36	38
18.....	20	21	22	23	24	25	26	27	28	29	30	31	33	35	36	38	40
19.....	21	22	23	24	25	26	27	28	29	30	31	32	34	36	39	41	43
20.....	22	23	25	26	27	28	29	30	31	32	33	34	36	38	41	43	45
21.....	24	25	26	27	28	29	30	31	32	34	35	36	38	40	43	45	47
22.....	25	26	27	28	29	31	32	33	34	35	36	38	40	41	45	47	49
23.....	26	27	28	29	31	32	33	34	36	37	38	39	42	44	47	49	51
24.....	27	28	29	31	32	33	35	36	37	38	40	41	44	46	49	51	53
25.....	28	29	31	32	33	35	36	37	39	40	41	43	45	48	51	53	55
26.....	29	31	32	33	35	36	37	39	40	42	43	44	47	50	53	55	58
27.....	30	32	33	35	36	37	39	40	42	43	45	46	49	52	55	58	60
28.....	31	33	34	36	37	39	40	42	43	45	46	48	51	54	57	60	62
29.....	32	34	36	37	39	40	42	43	45	46	48	49	53	56	59	62	64
30.....	34	35	37	38	40	42	43	45	46	48	50	51	54	58	61	64	

TABLE 2.—*Deduction for rectangular defects—Continued*

End dimen- sions, inches	Length of defect—feet																																																																																																																																																																																																																																																																																																																																																																																																																																																																																																																																																																																																																																																																																																																																																																																																																																																																																																																																																																																																																																																																																																																																																																																																																																																																																																																																																																																																																																																																																																																																																																																							
	4	5	6	7	8	9	10	11	12	13	14	15	16	17	18	19	20																																																																																																																																																																																																																																																																																																																																																																																																																																																																																																																																																																																																																																																																																																																																																																																																																																																																																																																																																																																																																																																																																																																																																																																																																																																																																																																																																																																																																																																																																																																																																																							
	Contents—board feet in tens																																																																																																																																																																																																																																																																																																																																																																																																																																																																																																																																																																																																																																																																																																																																																																																																																																																																																																																																																																																																																																																																																																																																																																																																																																																																																																																																																																																																																																																																																																																																																																																							
9 x 10--	2	3	4	4	5	5	6	7	7	8	8	9	10	10	11	11	12	12	13	13	14	14	15	15	16	16	17	17	18	18	19	19	20	20	21	21	22	22	23	23	24	24	25	25	26	26	27	27	28	28	29	29	30	30	31	31	32	32	33	33	34	34	35	35	36	36	37	37	38	38	39	39	40	40	41	41	42	42	43	43	44	44	45	45	46	46	47	47	48	48	49	49	50	50	51	51	52	52	53	53	54	54	55	55	56	56	57	57	58	58	59	59	60	60	61	61	62	62	63	63	64	64	65	65	66	66	67	67	68	68	69	69	70	70	71	71	72	72	73	73	74	74	75	75	76	76	77	77	78	78	79	79	80	80	81	81	82	82	83	83	84	84	85	85	86	86	87	87	88	88	89	89	90	90	91	91	92	92	93	93	94	94	95	95	96	96	97	97	98	98	99	99	100	100	101	101	102	102	103	103	104	104	105	105	106	106	107	107	108	108	109	109	110	110	111	111	112	112	113	113	114	114	115	115	116	116	117	117	118	118	119	119	120	120	121	121	122	122	123	123	124	124	125	125	126	126	127	127	128	128	129	129	130	130	131	131	132	132	133	133	134	134	135	135	136	136	137	137	138	138	139	139	140	140	141	141	142	142	143	143	144	144	145	145	146	146	147	147	148	148	149	149	150	150	151	151	152	152	153	153	154	154	155	155	156	156	157	157	158	158	159	159	160	160	161	161	162	162	163	163	164	164	165	165	166	166	167	167	168	168	169	169	170	170	171	171	172	172	173	173	174	174	175	175	176	176	177	177	178	178	179	179	180	180	181	181	182	182	183	183	184	184	185	185	186	186	187	187	188	188	189	189	190	190	191	191	192	192	193	193	194	194	195	195	196	196	197	197	198	198	199	199	200	200	201	201	202	202	203	203	204	204	205	205	206	206	207	207	208	208	209	209	210	210	211	211	212	212	213	213	214	214	215	215	216	216	217	217	218	218	219	219	220	220	221	221	222	222	223	223	224	224	225	225	226	226	227	227	228	228	229	229	230	230	231	231	232	232	233	233	234	234	235	235	236	236	237	237	238	238	239	239	240	240	241	241	242	242	243	243	244	244	245	245	246	246	247	247	248	248	249	249	250	250	251	251	252	252	253	253	254	254	255	255	256	256	257	257	258	258	259	259	260	260	261	261	262	262	263	263	264	264	265	265	266	266	267	267	268	268	269	269	270	270	271	271	272	272	273	273	274	274	275	275	276	276	277	277	278	278	279	279	280	280	281	281	282	282	283	283	284	284	285	285	286	286	287	287	288	288	289	289	290	290	291	291	292	292	293	293	294	294	295	295	296	296	297	297	298	298	299	299	300	300	301	301	302	302	303	303	304	304	305	305	306	306	307	307	308	308	309	309	310	310	311	311	312	312	313	313	314	314	315	315	316	316	317	317	318	318	319	319	320	320	321	321	322	322	323	323	324	324	325	325	326	326	327	327	328	328	329	329	330	330	331	331	332	332	333	333	334	334	335	335	336	336	337	337	338	338	339	339	340	340	341	341	342	342	343	343	344	344	345	345	346	346	347	347	348	348	349	349	350	350	351	351	352	352	353	353	354	354	355	355	356	356	357	357	358	358	359	359	360	360	361	361	362	362	363	363	364	364	365	365	366	366	367	367	368	368	369	369	370	370	371	371	372	372	373	373	374	374	375	375	376	376	377	377	378	378	379	379	380	380	381	381	382	382	383	383	384	384	385	385	386	386	387	387	388	388	389	389	390	390	391	391	392	392	393	393	394	394	395	395	396	396	397	397	398	398	399	399	400	400	401	401	402	402	403	403	404	404	405	405	406	406	407	407	408	408	409	409	410	410	411	411	412	412	413	413	414	414	415	415	416	416	417	417	418	418	419	419	420	420	421	421	422	422	423	423	424	424	425	425	426	426	427	427	428	428	429	429	430	430	431	431	432	432	433	433	434	434	435	435	436	436	437	437	438	438	439	439	440	440	441	441	442	442	443	443	444	444	445	445	446	446	447	447	448	448	449	449	450	450	451	451	452	452	453	453	454	454	455	455	456	456	457	457	458	458	459	459	460	460	461	461	462	462	463	463	464	464	465	465	466	466	467	467	468	468	469	469	470	470	471	471	472	472	473	473	474	474	475	475	476	476	477	477	478	478	479	479	480	480	481	481	482	482	483	483	484	484	485	485	486	486	487	487	488	488	489	489	490	490	491	491	492	492	493	493	494	494	495	495	496	496	497	497	498	498	499	499	500	500	501	501	502	502	503	503	504	504	505	505	506	506	507	507	508	508	509	509	510	510	511	511	512	512	513	513	514	514	515	515	516	516	517	517	518	518	519	519	520	520	521	521	522	522	523	523	524	524	525	525	526	526	527	527	528	528	529	529	530	530	531	531	532	532	533	533	534	534	535	535	536	536	537	537	538	538	539	539	540	540	541	541	542	542	543	543	544	544	545	545	546	546	547	547	548	548	549	549	550	550	551	551	552	552	553	553	554	554	555	555	556	556	557	557	558	558	559	559	560	560	561	561	562	562	563	563	564	564	565	565	566	566	567	567	568	568	569	569	570	570	571	571	572	572	573	573	574	574	575	575	576	576	577	577	578	578	579	579	580	580	581	581	582	582	583	583	584	584	585	585	586	586	587	587	588	588	589	589	590	590	591	591	592	592	593	593	594	594	595	595	596	596	597	597	598	598	599	599	600	600	601	601	602	602	603	603	604	604	605	605	606	606	607	607	608	608	609	609	610	610	611	611	612	612	613	613	614	614	615	615	616	616	617	617	618	618	619	619	620	620	621	621	622	622	623	623	624	624	625	625	626	626	627	627	628	628	629	629	630	630	631	631	632	632	633	633	634	634	635	635	636	636	637	637	638	638	639	639	640	640	641	641	642	642	643	643	644	644	645	645	646	646	647	647	648	648	649	649	650	650	651	651	652	652	653	653	654	654	655	655	656	656	657	657	658	658	659	659	660	660	661	661	662	662	663	663	664	664	665	665	666	666	667	667	668	668	669	669	670	670	671	671	672	672	673	673	674	674	675	675	676	676	677	677	678	678	679	679	680	680	681	681	682	682	683	683	684	684	685	685	686	686	687	687	688	688	689	689	690	690	691	691	692	692	693	693	694	694	695	695	696	696	697	697	698	698	699	699	700	700	701	701	702	702	703	703	704	704	705	705	706	706	707	707	708	708	709	709	710	710	711	711	712	712	713	713	714	714	715	715	716	716	717	717	718	718	719	719	720	720	721	721	722	722	723	723	724	724	725	725	726	726	727	727	728	728	729	729	730	730	731	731	732	732	733	733	734	734	735	735	736	736	737	737	738	738	739	739	740	740	741	741	742	742	743	743	744	744	745	745	746	746	747	747	748	748	749	749	750	750	751	751	752	752	753	753	754	754	755	755	756	756	757	757	758	758	759	759	760	760	761	761	762	762	763	763	764	764	765	765	766	766	767	767

TABLE 2.—Deduction for rectangular defects—Continued

End dimensions, inches	Length of defect—feet															
	21	22	23	24	25	26	27	28	29	30	31	32	34	36	38	40
	Contents—board feet in tens															
9 x 10.....	13	13	14	14	15	16	16	17	17	18	19	19	20	22	23	24
11.....	14	15	15	16	16	17	18	18	19	20	20	21	22	22	23	24
12.....	15	16	17	17	18	19	19	20	21	22	22	23	24	25	27	29
13.....	16	17	18	19	20	20	21	22	23	23	24	25	26	27	28	30
14.....	18	18	19	20	21	22	23	24	24	25	26	27	28	29	31	32
15.....	19	20	21	22	23	24	25	26	27	28	29	30	31	33	35	36
16.....	20	21	22	23	24	25	26	27	28	29	30	31	33	35	38	38
17.....	21	22	23	24	26	27	28	29	30	31	32	33	35	37	39	41
18.....	23	24	25	26	27	28	29	30	31	32	33	35	37	39	41	43
19.....	24	25	26	27	28	30	31	32	33	34	35	36	39	41	43	46
20.....	25	26	28	29	30	31	32	34	35	36	37	38	41	43	46	48
21.....	26	28	29	30	32	33	34	35	37	38	39	40	43	45	48	50
22.....	28	29	30	32	33	34	36	37	38	40	41	42	45	48	50	53
23.....	29	30	32	33	34	36	37	39	40	41	43	44	47	50	52	55
24.....	30	32	33	35	36	37	39	40	42	43	45	46	49	52	55	58
25.....	32	33	34	36	38	39	40	42	44	45	46	48	51	54	57	60
26.....	33	34	36	37	39	41	42	44	45	47	48	50	53	56	59	62
27.....	34	36	37	39	40	42	44	45	47	49	50	52	55	58	62	65
28.....	35	37	39	40	42	44	45	47	49	50	52	54	57	60	64	67
29.....	37	38	40	42	44	45	47	49	50	52	54	56	59	63	66	70
30.....	38	40	41	43	45	47	49	50	52	54	56	58	61	65	68	72
10 x 11.....	15	16	17	18	18	19	20	21	21	22	23	23	25	26	28	29
12.....	17	18	18	19	20	21	22	22	23	24	25	26	27	29	30	32
13.....	18	19	20	21	22	23	23	24	25	26	27	28	29	31	33	35
14.....	20	21	21	22	23	24	25	26	27	28	29	30	32	34	35	37
15.....	21	22	23	24	25	26	27	28	29	30	31	32	34	36	38	40
16.....	22	23	25	26	27	28	29	30	31	32	33	34	36	38	41	43
17.....	24	25	26	27	28	29	31	32	33	34	35	36	39	41	43	45
18.....	25	26	28	29	30	31	32	34	35	36	37	38	41	43	46	48
19.....	27	28	29	30	32	33	34	35	37	38	39	41	43	46	48	51
20.....	28	29	31	32	33	35	36	37	39	40	41	43	45	48	51	53
21.....	29	31	32	34	35	36	38	39	41	42	43	45	48	50	53	56
22.....	31	32	34	35	27	38	40	41	43	44	45	47	50	53	56	59
23.....	32	34	35	37	38	40	41	43	44	46	48	49	52	55	58	61
24.....	34	35	37	38	40	42	43	45	46	48	50	51	54	58	61	64
25.....	35	37	38	40	42	43	45	47	48	50	52	53	57	60	63	67
26.....	36	38	40	42	43	45	47	49	50	52	54	55	59	62	66	69
27.....	38	40	41	43	45	47	49	50	52	54	56	58	61	65	68	72
28.....	39	41	43	45	47	49	50	52	54	56	58	60	63	67	71	75
29.....	41	43	44	46	48	50	52	54	56	58	60	62	66	70	73	77
30.....	42	44	46	48	50	52	54	56	58	60	62	64	68	72	76	80

TABLE 2.—*Deduction for rectangular defects*—Continued

End dimensions, inches	Length of defect—feet																			
	4	5	6	7	8	9	10	11	12	13	14	15	16	17	18	19	20			
	Contents—board feet in tens																			
11 x 12...	4	4	5	6	7	8	9	10	11	11	12	13	14	15	16	17	18			
13...	4	5	6	7	8	9	10	10	11	12	13	14	15	16	17	18	19			
14...	4	5	6	7	8	9	10	11	12	13	14	15	16	17	18	20	21			
15...	4	6	7	8	9	10	11	12	13	14	15	16	18	19	20	21	22			
16...	5	6	7	8	9	11	12	13	14	15	16	18	19	20	21	22	23			
17...	5	6	7	9	10	11	12	14	15	16	17	19	20	21	22	24	25			
18...	5	7	8	9	11	12	13	15	16	17	18	20	21	22	24	25	26			
19...	6	7	8	10	11	13	14	15	17	18	20	21	22	24	25	26	28			
20...	6	7	9	10	12	13	15	16	18	19	21	22	23	25	26	28	29			
21...	6	8	9	11	12	14	15	17	18	20	22	23	25	26	28	29	31			
22...	6	8	10	11	13	15	16	18	19	21	23	24	26	27	29	31	32			
23...	7	8	10	12	13	15	17	19	20	22	24	25	27	29	30	32	34			
24...	7	9	11	12	14	16	18	19	21	23	25	26	28	30	32	33	35			
25...	7	9	11	13	15	16	18	20	22	24	26	28	29	31	33	35	37			
26...	8	10	11	13	15	17	19	21	23	25	27	29	31	32	34	36	38			
27...	8	10	12	14	16	18	20	22	24	26	28	30	32	34	36	38	40			
28...	8	10	12	14	16	18	21	23	25	27	29	31	33	35	37	39	41			
29...	9	11	13	15	17	19	21	23	26	28	30	32	34	36	38	40	43			
30...	9	11	13	15	18	20	22	24	26	29	31	33	35	37	40	42	44			
12 x 13...	4	5	6	7	8	9	10	11	12	14	15	16	17	18	19	20	21			
14...	4	6	7	8	9	10	11	12	13	15	16	17	18	19	20	21	22			
15...	5	6	7	8	10	11	12	13	14	16	17	18	19	20	22	23	24			
16...	5	6	8	9	10	12	13	14	15	17	18	19	20	22	23	24	26			
17...	5	7	8	10	11	12	14	15	16	18	19	20	22	23	24	26	27			
18...	6	7	9	10	12	13	14	16	17	19	20	22	23	24	26	27	29			
19...	6	8	9	11	12	14	15	17	18	20	21	23	24	26	27	29	30			
20...	6	8	10	11	13	14	16	18	19	21	22	24	26	27	29	30	32			

TABLE 2.—Deduction for rectangular defects—Continued

End di- mensions, inches	Length of defect—feet															
	21	22	23	24	25	26	27	28	29	30	31	32	34	36	38	40
	Contents—board feet in tens															
11 x 12.....	18	19	20	21	22	23	24	25	26	26	27	28	29	30	31	32
13.....	20	21	22	23	24	25	26	27	28	29	30	31	32	34	36	38
14.....	22	23	24	25	26	27	28	29	30	31	32	33	35	37	39	41
15.....	23	24	25	26	28	29	30	31	32	33	34	35	37	40	42	44
16.....	25	26	27	28	29	31	32	33	34	35	36	38	40	42	45	47
17.....	26	27	29	30	31	32	34	35	36	37	39	40	42	45	47	50
18.....	28	29	30	32	33	34	36	37	38	40	41	42	45	48	50	53
19.....	29	31	32	33	35	36	38	39	40	42	43	45	47	50	53	56
20.....	31	32	34	35	37	38	40	41	43	44	45	47	50	53	56	59
21.....	32	34	35	37	38	40	42	43	45	46	48	49	52	55	59	62
22.....	34	35	37	39	40	42	44	45	47	48	50	52	55	58	61	65
23.....	35	37	39	40	42	44	46	47	49	51	52	54	57	61	64	67
24.....	37	39	40	42	44	46	48	49	51	53	55	56	60	63	67	70
25.....	38	40	42	44	46	48	50	51	53	55	57	59	62	66	70	73
26.....	40	42	44	46	48	50	51	53	55	57	59	61	65	69	72	76
27.....	42	44	46	48	50	51	53	55	57	59	61	63	67	71	75	79
28.....	43	45	47	49	51	53	55	57	60	62	64	66	70	74	78	82
29.....	45	47	49	51	53	55	57	60	62	64	66	68	72	77	81	85
30.....	46	48	51	53	55	57	59	62	64	66	68	70	75	79	84	88
12 x 13.....	22	23	24	25	26	27	28	29	30	31	32	33	35	37	40	42
14.....	24	25	26	27	28	29	30	31	32	34	35	36	38	40	43	45
15.....	25	26	28	29	30	31	32	34	35	36	37	38	41	43	46	48
16.....	27	28	29	31	32	33	35	36	37	38	40	41	44	46	49	51
17.....	29	30	31	33	34	35	37	38	39	41	42	44	46	49	52	54
18.....	30	32	33	35	36	37	39	40	42	43	45	46	49	52	55	58
19.....	32	33	35	36	38	40	41	43	44	46	47	49	52	55	58	61
20.....	34	35	37	38	40	42	43	45	46	48	50	51	54	58	61	64

TABLE 2.—Deduction for rectangular defects—Continued

End dimensions, inches	Length of defect—feet																			
	4	5	6	7	8	9	10	11	12	13	14	15	16	17	18	19	20			
	Contents—board feet in tens																			
12 x 21..	7	8	10	12	13	15	17	18	20	22	24	25	27	29	30	32	34			
22..	7	9	11	12	14	16	18	19	21	23	25	26	28	29	30	32	33			
23..	7	9	11	13	15	17	18	20	22	24	26	28	29	31	33	35	37			
24..	8	10	12	13	15	17	19	21	23	25	27	29	31	33	35	36	38			
25..	8	10	12	14	16	18	20	22	24	26	28	30	32	34	36	38	40			
26..	8	10	12	15	17	19	21	23	25	27	29	31	33	35	37	40	42			
27..	9	11	13	15	17	19	22	24	26	28	30	32	35	37	39	41	43			
28..	9	11	13	16	18	20	22	25	27	29	31	34	36	38	40	43	45			
29..	9	12	14	16	19	21	23	26	28	30	32	35	37	39	42	44	46			
30..	10	12	14	17	19	22	24	26	29	31	34	36	38	41	43	46	48			
13 x 14..	5	6	7	8	10	11	12	13	15	16	17	18	19	21	22	23	24			
15..	5	6	8	9	10	12	13	14	16	17	18	19	21	22	23	25	26			
16..	6	7	8	10	11	12	14	15	17	18	19	21	22	24	25	26	28			
17..	6	7	9	10	12	13	15	16	18	19	21	22	24	25	27	28	29			
18..	6	8	9	11	12	14	16	17	19	20	22	23	25	27	28	30	31			
19..	7	8	10	12	13	15	16	18	20	21	23	25	26	28	30	31	33			
20..	7	9	10	12	14	16	17	19	21	23	24	26	28	29	31	33	35			
21..	7	9	11	13	15	16	18	20	22	24	25	27	29	31	33	35	36			
22..	8	10	11	13	15	17	19	21	23	25	27	29	31	32	34	36	38			
23..	8	10	12	14	16	18	20	22	24	26	28	30	32	34	36	38	40			
24..	8	10	12	15	17	19	21	23	25	27	29	31	33	35	37	40	42			
25..	9	11	13	15	17	20	22	24	26	28	30	32	35	37	39	41	43			
26..	9	11	14	16	18	20	23	25	27	29	32	34	36	38	41	43	45			
27..	9	12	14	16	19	21	23	26	28	30	33	35	37	40	42	44	47			
28..	10	12	15	17	19	22	24	27	29	32	34	36	39	41	44	46	49			
29..	10	13	15	18	20	23	25	28	30	33	35	38	40	43	45	48	50			
30..	10	13	16	18	21	23	26	29	31	34	36	39	42	44	47	49	52			
14 x 15..	6	7	8	10	11	13	14	15	17	18	20	21	22	24	25	27	28			
16..	6	7	9	10	12	13	15	16	18	19	21	22	24	25	27	28	30			
17..	6	8	10	11	13	14	16	17	19	21	22	24	25	27	29	30	32			
18..	7	8	10	12	13	15	17	18	20	22	24	25	27	29	30	32	34			
19..	7	9	11	12	14	16	18	20	21	23	25	27	28	30	32	34	35			
20..	7	9	11	13	15	17	21	21	22	24	26	28	30	32	34	35	37			
21..	8	10	12	14	16	18	20	22	24	25	27	29	31	33	35	37	39			
22..	8	10	12	14	16	18	21	23	25	27	29	31	33	35	37	39	41			
23..	9	11	13	15	17	19	21	24	26	28	30	32	34	36	39	41	43			
24..	9	11	13	16	18	20	22	25	27	29	31	34	36	38	40	43	45			
25..	9	12	14	16	19	21	23	26	28	30	33	35	37	40	42	44	47			
26..	10	12	15	17	19	22	24	27	29	32	34	36	39	41	44	46	49			
27..	10	13	15	18	20	23	25	28	30	33	35	38	40	43	45	48	50			

TABLE 2.—Deduction for rectangular defects—Continued

End dimensions, inches	Length of defects—feet															
	21	22	23	24	25	26	27	28	29	30	31	32	34	36	38	40
	Contents—board feet in tons															
12 x 21..	35	37	39	40	42	44	45	47	49	50	52	54	57	60	64	67
22..	37	39	40	42	44	46	48	49	51	53	55	56	60	63	67	70
23..	39	40	42	44	46	48	49	50	52	53	55	57	59	63	66	74
24..	40	42	44	46	48	50	52	54	56	58	60	61	65	69	73	77
25..	42	44	46	48	50	52	54	56	58	60	62	64	68	72	76	80
26..	44	46	48	50	52	54	56	58	60	62	64	67	71	75	79	83
27..	45	48	50	52	54	56	58	60	63	65	67	69	73	78	82	86
28..	47	49	52	54	56	58	60	63	65	67	69	72	76	81	85	90
29..	49	51	53	56	58	60	63	65	67	70	72	74	79	84	88	93
30..	50	53	55	58	60	62	65	67	70	72	74	77	82	86	91	96
13 x 14..	25	27	28	29	30	32	33	34	35	36	38	39	41	44	46	49
15..	27	29	30	31	32	34	35	36	38	39	40	42	44	47	49	52
16..	29	31	32	33	35	36	37	39	40	42	43	44	47	50	53	55
17..	31	32	34	35	37	38	40	41	43	44	46	47	50	53	56	59
18..	33	34	36	37	39	41	42	44	45	47	48	50	53	56	59	62
19..	35	36	38	40	41	43	44	46	48	49	51	53	56	59	63	66
20..	36	38	40	42	43	45	47	49	50	52	54	55	59	62	66	69
21..	38	40	42	44	46	47	49	51	53	55	56	58	62	66	69	73
22..	40	42	44	46	48	50	51	53	55	57	59	61	65	69	72	76
23..	42	44	46	48	50	52	54	56	58	60	62	64	68	72	76	80
24..	44	46	48	50	52	54	56	58	60	62	64	67	71	75	79	83
25..	46	49	50	52	54	56	58	61	63	65	67	69	74	78	82	87
26..	47	50	52	54	56	59	61	63	65	68	70	72	77	81	86	90
27..	49	51	54	56	58	61	63	66	68	70	73	75	80	84	89	94
28..	51	53	56	58	61	63	66	68	70	73	75	78	83	87	92	97
29..	53	55	58	60	63	65	68	70	73	75	78	80	85	90	96	101
30..	55	57	60	62	65	68	70	73	75	78	81	83	88	94	99	104
14 x 15..	29	31	32	34	35	36	38	39	41	42	43	45	48	50	53	56
16..	31	33	34	36	37	39	40	42	43	45	46	48	51	54	57	60
17..	33	35	36	38	40	41	43	44	46	48	49	51	54	57	60	63
18..	35	37	39	40	42	44	45	47	49	50	52	54	57	60	64	67
19..	37	39	41	43	44	46	48	50	51	53	55	57	60	64	67	71
20..	39	41	43	45	47	49	50	52	54	56	58	60	63	67	71	75
21..	41	43	45	47	49	51	53	55	57	59	61	63	67	71	74	78
22..	43	45	47	49	51	53	55	57	60	62	64	66	70	74	78	82
23..	45	47	49	52	54	56	58	60	62	64	67	69	73	77	82	86
24..	47	49	52	54	56	58	60	63	65	67	69	72	76	81	85	90
25..	49	51	54	56	58	61	63	65	68	70	72	75	79	84	89	93
26..	51	53	56	58	61	63	66	68	70	73	75	78	83	87	92	97
27..	53	55	58	60	63	66	68	71	73	76	78	81	86	91	96	101

TABLE 2.—*Deduction for rectangular defects—Continued*

End dimen- sions, inches	Length of defect—feet																	
	4	5	6	7	8	9	10	11	12	13	14	15	16	17	18	19	20	
	Contents—board feet in tons																	
14 x 28..	10	13	16	18	21	24	26	29	31	34	37	39	42	44	47	50	52	
	29..	11	14	16	19	22	24	27	30	32	35	38	41	43	46	49	51	54
	30..	11	14	17	20	22	25	28	31	34	36	39	42	45	48	50	53	56
15 x 16..	6	8	10	11	13	14	16	18	19	21	22	24	26	27	29	30	32	
	17..	7	8	10	12	14	15	17	19	20	22	24	26	27	29	31	32	34
	18..	7	9	11	13	14	16	18	20	22	23	25	27	29	31	32	34	36
	19..	8	10	11	13	15	17	19	21	23	25	27	28	30	32	34	36	38
	20..	8	10	12	14	16	18	20	22	24	26	28	30	32	34	36	38	40
	21..	8	10	13	15	17	19	21	23	25	27	29	32	34	36	38	40	43
	22..	9	11	13	15	18	20	22	24	26	29	31	33	35	37	40	42	44
	23..	9	12	14	16	18	21	23	25	28	30	32	34	37	39	41	44	46
	24..	10	12	14	17	19	22	24	26	29	31	34	36	38	41	43	46	48
	25..	10	12	15	18	20	22	25	28	30	32	35	38	40	42	45	48	50
	26..	10	13	16	18	21	23	26	29	31	34	36	39	42	44	47	49	53
	27..	11	14	16	19	22	24	27	30	32	35	38	40	43	46	49	51	54
28..	11	14	17	20	22	25	28	31	34	36	39	42	45	48	50	53	56	
29..	12	14	17	20	23	26	29	32	35	38	41	44	46	49	52	55	58	
30..	12	15	18	21	24	27	30	33	36	39	42	45	48	51	54	57	60	
16 x 17..	7	9	11	13	15	16	18	20	22	24	25	27	29	31	33	34	36	
	18..	8	10	12	13	15	17	19	21	23	25	27	29	31	33	35	36	38
	19..	8	10	12	14	16	18	20	22	24	26	28	30	32	34	36	39	41
	20..	9	11	13	15	17	19	21	23	26	28	30	32	34	36	38	41	43
	21..	9	11	13	16	18	20	22	25	27	29	31	34	36	38	40	43	45
	22..	9	12	14	16	19	21	23	26	28	31	33	35	38	40	42	45	47
	23..	10	12	15	17	20	22	25	27	29	32	34	37	39	42	44	47	49
	24..	10	13	15	18	20	23	26	28	31	33	36	38	41	44	46	49	51

TABLE 2.—*Deduction for rectangular defects*—Continued

End dimensions, inches	Length of defect—feet															
	21	22	23	24	25	26	27	28	29	30	31	32	34	36	38	40
	Contents—board feet in tens															
14 x 23.....	55	57	60	63	65	68	71	73	76	78	81	84	89	94	99	105
20.....	57	60	62	65	68	70	73	76	78	81	84	87	92	97	103	108
30.....	59	62	64	67	70	73	76	78	81	84	87	90	95	101	106	112
15 x 16.....	34	35	37	38	40	42	43	45	46	48	50	51	54	58	61	64
17.....	36	37	39	41	42	44	46	48	49	51	53	54	58	61	65	68
18.....	38	40	41	43	45	47	49	50	52	54	56	58	61	65	68	72
19.....	40	42	44	46	48	49	51	53	55	57	59	61	65	68	72	76
20.....	42	44	46	48	50	52	54	56	58	60	62	64	68	72	76	80
21.....	44	46	48	50	52	55	57	59	61	63	65	67	71	76	80	84
22.....	46	48	51	53	55	57	59	62	64	66	68	70	75	79	84	88
23.....	48	51	53	55	58	60	62	64	67	69	71	74	78	83	87	92
24.....	50	53	55	58	60	62	65	67	70	72	74	77	82	86	91	96
25.....	52	55	58	60	62	65	68	70	72	75	78	80	85	90	95	100
26.....	55	57	60	62	65	68	70	73	75	78	81	83	88	94	99	104
27.....	57	59	62	65	68	70	73	76	78	81	84	86	92	97	103	108
28.....	59	62	64	67	70	73	76	78	81	84	87	90	95	101	106	112
29.....	61	64	67	70	72	75	78	81	84	87	90	93	99	104	110	116
30.....	63	66	69	72	75	78	81	84	87	90	93	96	102	108	114	120
16 x 17.....	38	40	42	44	45	47	49	51	53	54	56	58	62	65	69	73
18.....	40	42	44	46	48	50	52	54	56	58	60	61	65	69	73	77
19.....	43	45	47	49	51	53	55	57	59	61	63	65	69	73	77	81
20.....	45	47	49	51	53	55	58	60	62	64	66	68	73	77	81	85
21.....	47	49	52	54	56	58	60	63	65	67	69	72	76	81	85	90
22.....	49	52	54	56	59	61	63	66	68	70	73	75	80	84	89	94
23.....	52	54	56	59	61	64	66	69	71	74	76	79	83	88	93	98
24.....	54	56	59	61	64	67	69	72	74	77	79	82	87	92	97	102

TABLE 2.—Deduction for rectangular defects—Continued

End dimen- sions, inches	Length of defect—feet																			
	4	5	6	7	8	9	10	11	12	13	14	15	16	17	18	19	20			
	Contents—board feet in tens																			
16 x 25..	11	13	16	19	21	24	27	29	32	35	37	40	43	45	48	51	53			
26..	11	14	17	19	22	25	28	31	33	36	39	42	44	47	50	53	55			
27..	12	14	17	20	23	26	29	32	35	37	40	43	46	49	52	55	58			
28..	12	15	18	21	24	27	30	33	36	39	42	45	48	51	54	57	60			
29..	12	15	19	22	25	28	31	34	37	40	43	46	49	53	56	59	62			
30..	13	16	19	22	26	29	32	35	38	42	45	48	51	54	58	61	64			
17 x 18..	8	10	12	14	16	18	20	22	24	27	29	31	33	35	37	39	41			
19..	9	11	13	15	17	19	22	24	26	28	30	32	34	37	39	41	43			
20..	9	11	14	16	18	20	23	25	27	29	32	34	36	39	41	43	45			
21..	10	12	14	17	19	21	24	26	29	31	33	36	38	40	43	45	48			
22..	10	12	15	17	20	22	25	27	30	32	35	37	40	42	45	47	50			
23..	10	13	16	18	21	23	26	29	31	34	36	39	42	44	47	50	52			
24..	11	14	16	19	22	24	27	30	33	35	38	41	44	46	49	52	54			
25..	11	14	17	20	23	26	28	31	34	37	40	42	45	48	51	54	57			
26..	12	15	18	21	24	27	29	32	35	38	41	44	47	50	53	56	59			
27..	12	15	18	21	24	28	31	34	37	40	43	46	49	52	55	58	61			
28..	13	16	19	22	25	29	32	35	38	41	44	48	51	54	57	60	63			
29..	13	16	20	23	26	30	33	36	39	43	46	49	53	56	59	62	66			
30..	14	17	20	24	27	31	34	37	41	44	48	51	54	58	61	65	68			
18 x 19..	9	11	14	16	18	21	23	25	27	30	32	34	36	39	41	43	46			
20..	10	12	14	17	19	22	24	26	29	31	34	36	38	41	43	46	48			
21..	10	13	15	18	20	23	25	28	30	33	35	38	40	43	45	48	50			
22..	11	13	16	18	21	24	26	29	32	34	37	40	42	45	48	50	53			
23..	11	14	17	19	22	25	28	30	33	36	39	41	44	47	50	52	55			
24..	12	14	17	20	23	26	29	32	35	37	40	43	46	49	52	55	58			
25..	12	15	18	21	24	27	30	33	36	39	42	45	48	51	54	57	60			
26..	12	16	19	22	25	28	31	34	37	41	44	47	50	53	56	59	62			
27..	13	16	19	23	26	29	32	36	39	42	45	49	52	55	58	62	66			
28..	13	17	20	24	27	30	34	37	40	44	47	50	54	57	60	64	67			
29..	14	17	21	24	28	31	35	38	42	45	49	52	56	59	63	66	70			
30..	14	18	22	25	29	32	36	40	43	47	50	54	58	61	65	68	72			
19 x 20..	10	13	15	18	20	23	25	28	30	33	35	38	41	43	46	48	51			
21..	11	13	16	19	21	24	27	29	32	35	37	40	43	45	48	51	53			
22..	11	14	17	20	22	25	28	31	33	36	39	42	45	47	50	53	56			
23..	12	15	17	20	23	26	29	32	35	38	41	44	47	50	52	55	58			
24..	12	15	18	21	24	27	30	33	36	40	43	46	49	52	55	58	61			
25..	13	16	19	22	25	28	32	35	38	41	44	48	51	54	57	60	63			
26..	13	16	20	23	26	30	33	36	40	43	46	49	53	56	59	63	66			
27..	14	17	21	24	27	31	34	38	41	44	48	51	55	58	62	65	68			

TABLE 2.—*Deduction for rectangular defects—Continued*

End dimensions, inches	Length of defect—feet															
	31	32	33	34	35	36	37	38	39	40	41	42	43	44	45	46
	Contents—board feet in tons															
16 x 25	56	59	61	64	67	69	72	75	77	80	83	85	91	96	101	107
25	58	61	64	67	69	72	75	78	80	83	86	89	94	100	105	111
27	60	63	66	69	72	75	78	81	84	86	89	92	98	104	109	115
28	63	66	69	72	75	78	81	84	87	90	93	96	102	108	113	119
29	65	68	71	74	77	80	84	87	90	93	96	99	105	111	118	124
30	67	70	74	77	80	83	86	90	93	96	99	102	109	115	122	128
17 x 18	43	45	47	49	51	53	55	57	59	61	63	65	69	73	78	82
19	45	47	50	52	54	56	58	60	62	65	67	69	73	78	82	86
20	48	50	52	54	57	59	61	63	66	68	70	73	77	82	86	91
21	50	52	55	57	60	62	64	67	69	71	74	76	81	86	90	95
22	52	55	57	60	62	65	67	70	72	75	77	80	85	90	95	100
23	55	57	60	63	65	68	70	73	76	78	81	83	89	94	99	104
24	57	60	63	65	68	71	73	76	79	82	84	87	92	98	103	109
25	60	62	65	68	71	74	76	79	82	85	88	91	96	102	108	113
26	62	65	68	71	74	77	80	83	85	88	91	94	100	106	112	118
27	64	67	70	73	76	80	83	86	89	92	95	98	104	110	116	122
28	67	70	73	76	79	83	86	89	92	95	98	102	108	114	121	127
29	69	72	76	79	82	85	89	92	95	99	102	105	112	118	125	131
30	71	75	78	82	85	88	92	95	99	102	105	109	116	122	129	136
18 x 19	48	50	52	55	57	59	62	64	66	68	71	73	78	82	87	91
20	50	53	55	58	60	62	65	67	70	72	74	77	82	86	91	96
21	53	55	58	60	63	66	68	71	73	76	78	81	86	91	96	101
22	55	58	61	63	66	69	71	74	77	79	82	84	90	95	100	106
23	58	61	63	66	69	72	75	77	80	83	86	89	94	99	105	110
24	60	63	66	69	72	75	78	81	84	86	89	92	98	104	109	115
25	63	66	69	72	75	78	81	84	87	90	93	96	102	108	114	120
26	66	69	72	75	78	81	84	87	90	94	97	100	106	112	119	125
27	68	71	75	78	81	84	87	91	94	97	100	104	110	117	123	130
28	71	74	77	81	84	87	91	94	97	101	104	108	114	121	128	134
29	73	77	80	84	87	90	94	97	101	104	108	111	118	125	132	139
30	76	79	83	86	90	94	97	101	104	108	112	115	122	130	137	144
19 x 20	53	56	58	61	63	66	68	71	73	76	79	81	86	91	96	101
21	56	59	61	64	66	69	72	74	77	80	82	85	90	96	101	106
22	59	61	64	67	70	72	75	78	81	84	86	89	95	100	106	111
23	61	64	67	70	73	76	79	82	84	87	90	93	99	105	111	117
24	64	67	70	73	76	79	82	85	88	91	94	97	103	109	116	122
25	66	70	73	76	79	82	86	89	92	95	98	101	108	114	120	127
26	69	72	76	79	82	86	89	92	96	99	102	105	112	119	125	132
27	72	75	79	82	86	89	92	96	99	103	106	109	116	123	130	137

TABLE 2.—Deduction for rectangular defects—Continued

End dimensions, inches	Length of defect—feet																			
	4	5	6	7	8	9	10	11	12	13	14	15	16	17	18	19	20			
	Contents—board feet in tens																			
19 x 28....	14	18	21	25	28	32	35	39	43	46	50	53	57	60	64	67	71			
29....	15	18	22	26	29	33	37	40	44	48	51	55	59	62	66	70	73			
30....	15	19	23	27	30	34	38	42	46	49	53	57	61	65	68	72	76			
20 x 21....	11	14	17	20	22	25	28	31	34	36	39	42	45	48	50	53	56			
22....	12	15	18	21	23	26	29	32	35	38	41	44	47	50	53	56	59			
23....	12	15	18	21	25	28	31	34	37	40	43	46	49	52	55	58	61			
24....	13	16	19	22	26	29	32	35	38	42	45	48	51	54	58	61	64			
25....	13	17	20	23	27	30	33	37	40	43	47	50	53	57	60	63	67			
26....	14	17	21	24	28	31	35	38	42	45	49	52	55	59	62	66	69			
27....	14	18	22	25	29	32	36	40	43	47	50	54	58	61	65	68	72			
28....	15	19	22	26	30	34	37	41	45	49	52	56	60	63	67	71	75			
29....	15	19	23	27	31	35	39	43	46	50	54	58	62	66	70	73	77			
30....	16	20	24	28	32	36	40	44	48	52	56	60	64	68	72	76	80			
21 x 22....	12	15	18	22	25	28	31	34	37	40	43	46	49	52	55	59	62			
23....	13	16	19	23	26	29	32	35	39	42	45	48	52	55	58	61	64			
24....	13	17	20	24	27	30	34	37	40	44	47	50	54	57	60	64	67			
25....	14	18	21	24	28	32	35	38	42	46	49	52	56	60	63	66	70			
26....	15	18	22	25	29	33	36	40	44	47	51	55	58	62	66	69	73			
27....	15	19	23	26	30	34	38	42	45	49	53	57	60	64	68	72	76			
28....	16	20	24	27	31	35	39	43	47	51	55	59	63	67	71	74	78			
29....	16	20	24	28	32	37	41	45	49	53	57	61	65	69	73	77	81			
30....	17	21	25	29	34	38	42	46	50	55	59	63	67	71	76	80	84			
22 x 23....	13	17	20	24	27	30	34	37	40	44	47	51	54	57	61	64	67			
24....	14	18	21	25	28	32	35	39	42	46	49	53	56	60	63	67	70			
25....	15	18	22	26	29	33	37	40	44	48	51	55	59	62	66	70	73			

TABLE 2.—Deduction for rectangular defects—Continued

End dimensions, inches	Length of defect—feet																	
	21	22	23	24	25	26	27	28	29	30	31	32	34	36	38	40		
	Contents—board feet in tons																	
19 x 28.....	74	78	82	85	89	92	96	99	103	106	110	113	121	128	135	142		
29.....	77	81	84	88	92	96	99	103	107	110	114	118	125	132	140	147		
30.....	80	84	87	91	95	99	103	106	110	114	118	122	129	137	144	152		
20 x 21.....	59	62	64	67	70	73	76	78	81	84	87	90	95	101	106	112		
22.....	62	65	67	70	73	76	79	82	85	88	91	94	100	106	111	117		
23.....	64	67	71	74	77	80	83	86	89	92	95	98	104	110	117	123		
24.....	67	70	74	77	80	83	86	90	93	96	99	102	109	115	122	128		
25.....	70	73	77	80	83	87	90	93	97	100	103	107	113	120	127	133		
26.....	73	76	80	83	87	90	94	97	101	104	107	111	118	125	132	139		
27.....	76	79	83	86	90	94	97	101	104	108	112	115	122	130	137	144		
28.....	78	82	86	90	93	97	101	105	108	112	116	119	127	134	142	149		
29.....	81	85	89	93	97	101	104	108	112	116	120	124	131	139	147	155		
30.....	84	88	92	96	100	104	108	112	116	120	124	128	136	144	152	160		
21 x 22.....	65	68	71	74	77	80	83	86	89	92	95	99	105	111	117	123		
23.....	68	71	74	77	80	84	87	90	93	97	100	103	109	116	122	129		
24.....	71	74	77	81	84	87	91	94	97	101	104	108	114	121	128	134		
25.....	74	77	80	84	88	91	94	98	102	105	108	112	119	126	133	140		
26.....	76	80	84	87	91	95	98	102	106	109	113	116	124	131	138	146		
27.....	79	83	87	91	94	98	102	106	110	113	117	121	129	136	144	151		
28.....	82	86	90	94	98	102	106	110	114	118	122	125	133	141	149	157		
29.....	85	89	93	97	102	106	110	114	118	122	126	130	138	146	154	162		
30.....	88	92	97	101	105	109	113	118	122	126	130	134	143	151	160	168		
22 x 23.....	71	74	78	81	84	88	91	94	98	101	105	108	115	121	128	135		
24.....	74	77	81	84	88	92	95	99	102	106	109	113	120	127	134	141		
25.....	77	81	84	88	92	95	99	103	106	110	114	117	125	132	139	147		

TABLE 2.—Deduction for rectangular defects—Continued

End dimensions, inches	Length of defect—feet																			
	4	5	6	7	8	9	10	11	12	13	14	15	16	17	18	19	20			
	Contents—board feet in tons																			
22 x 26	15	19	23	27	31	34	38	42	46	50	53	57	61	65	69	72	76			
27	16	20	24	28	32	36	40	44	48	51	55	59	63	67	71	75	79			
28	16	21	25	29	33	37	41	45	49	53	57	62	66	70	74	78	82			
29	17	21	26	30	34	38	43	47	51	55	60	64	68	72	77	81	85			
30	18	22	26	31	35	40	44	48	53	57	62	66	70	75	79	84	88			
23 x 24	15	18	22	26	29	33	37	40	44	48	52	55	59	63	66	70	74			
25	15	19	23	27	31	34	38	42	46	50	54	58	61	65	69	73	77			
26	16	20	24	28	32	36	40	44	48	52	56	60	64	68	72	76	80			
27	17	21	25	29	33	37	41	46	50	54	58	62	66	70	75	79	83			
28	17	21	26	30	34	39	43	47	52	56	60	64	69	73	77	82	86			
29	18	22	27	31	36	40	44	49	53	58	62	67	71	76	80	84	89			
30	18	23	28	32	37	41	46	51	55	60	64	69	74	78	83	87	92			
24 x 25	16	20	24	28	32	36	40	44	48	52	56	60	64	68	72	76	80			
26	17	21	25	29	33	37	42	46	50	54	58	62	67	71	75	79	83			
27	17	22	26	30	35	39	43	48	52	56	60	65	69	73	78	82	86			
28	18	22	27	31	36	40	45	49	54	58	63	67	72	76	81	85	90			
29	19	23	28	32	37	42	46	51	56	60	65	70	74	79	84	88	93			
30	19	24	29	34	38	43	48	53	58	62	67	72	77	82	86	91	96			
25 x 26	17	22	26	30	35	39	43	48	52	56	61	65	69	74	78	82	87			
27	18	22	27	32	36	40	45	50	54	58	63	68	72	76	81	86	90			
28	19	23	28	33	37	42	47	51	56	61	65	70	75	79	84	89	93			
29	19	24	29	34	39	44	48	53	58	63	68	72	77	82	87	92	97			
30	20	25	30	35	40	45	50	55	60	65	70	75	80	85	90	95	100			
26 x 27	19	23	28	33	37	42	47	51	56	61	66	70	75	80	84	89	94			
28	19	24	29	34	39	44	49	53	58	63	68	73	78	83	87	92	97			
29	20	25	30	35	40	45	50	55	60	65	70	75	80	85	90	96	101			
30	21	26	31	36	42	47	52	57	62	68	73	78	83	88	94	99	104			
27 x 28	20	25	30	35	40	45	50	55	60	66	71	76	81	86	91	96	101			
29	21	26	31	37	42	47	52	57	63	68	73	78	84	89	94	99	104			
30	22	27	32	38	43	49	54	59	65	70	76	81	86	92	97	103	108			
28 x 29	22	27	32	38	43	49	54	60	65	70	76	81	87	92	97	103	108			
30	22	28	34	39	45	50	56	62	67	73	78	84	90	95	101	106	112			
29 x 30	23	29	35	41	46	52	58	64	70	75	81	87	93	99	104	110	116			

TABLE 2.—Deduction for rectangular defects—Continued

End dimensions, inches	Length of defect—feet															
	21	22	23	24	25	26	27	28	29	30	31	32	34	36	38	40
	Contents—board feet in tons															
22 x 26	80	84	88	92	95	99	103	107	111	114	118	122	130	137	145	158
27	83	87	91	95	99	103	107	111	115	119	123	127	135	143	150	158
28	86	90	94	99	103	107	111	115	119	123	127	131	140	148	156	164
29	89	94	98	102	106	111	115	119	123	128	132	136	145	153	162	170
30	92	97	101	106	110	114	119	123	128	132	136	141	150	158	167	176
23 x 24	77	81	85	88	92	96	99	103	107	110	114	118	125	132	140	147
25	80	84	88	92	96	100	104	107	111	115	119	123	130	138	146	153
26	84	88	92	96	100	104	108	112	116	120	124	128	136	144	151	159
27	87	91	95	99	104	108	112	116	120	124	128	132	141	149	157	166
28	90	94	99	103	107	112	116	120	125	129	133	137	146	155	163	172
29	93	98	102	107	111	116	120	125	129	133	138	142	151	160	169	178
30	97	101	106	110	115	120	124	129	133	138	143	147	156	166	175	184
24 x 25	84	88	92	96	100	104	108	112	116	120	124	128	136	144	152	160
26	87	92	96	100	104	108	112	116	121	125	129	133	141	150	158	166
27	91	95	99	104	108	112	117	121	125	130	134	138	147	156	164	173
28	94	99	103	108	112	116	121	125	130	134	139	143	152	161	170	179
29	97	102	107	111	116	121	125	130	135	139	144	148	158	167	176	186
30	101	106	110	115	120	125	130	134	139	144	149	154	163	173	182	192
25 x 26	91	95	100	104	108	113	117	121	126	130	134	139	147	156	165	173
27	94	99	104	108	112	117	122	126	130	135	140	144	153	162	171	180
28	98	103	107	112	117	121	126	131	135	140	145	149	159	168	177	187
29	102	106	111	116	121	126	130	135	140	145	150	155	164	174	184	193
30	105	110	115	120	125	130	135	140	145	150	155	160	170	180	190	200
26 x 27	98	103	108	112	117	122	126	131	136	140	145	150	159	168	178	187
28	102	107	112	116	121	126	131	136	141	146	150	155	165	175	184	194
29	106	111	116	121	126	131	136	141	146	151	156	161	171	181	191	201
30	109	114	120	125	130	135	140	146	151	156	161	166	177	187	198	208
27 x 28	106	111	116	121	126	131	136	141	146	151	156	161	171	181	192	202
29	110	115	120	125	130	136	141	146	151	157	162	167	177	188	198	209
30	113	119	124	130	135	140	146	151	157	162	167	173	184	194	205	216
28 x 29	114	119	125	130	135	141	146	152	157	162	168	173	184	195	206	217
30	118	123	129	134	140	146	151	157	162	168	174	179	190	202	215	224
29 x 30	122	128	133	139	145	151	157	162	168	174	180	186	197	209	220	232

TABLE 3.—*Deduction for squared defects*

[20 per cent deducted for kerf from solid board-foot contents]

End dimensions, inches	Length of defect—feet								
	4	5	6	7	8	9	10	11	12
	Contents—board feet in tons								
2 x 2.....							0.5	0.5	0.5
3 x 3.....		0.5	0.5	0.5	0.5	0.5	0.5	0.5	0.5
4 x 4.....	0.5	1	1	1	1	1	1	1	1
5 x 5.....	0.5	1	1	1	1	2	2	2	2
6 x 6.....	1	1	1	2	2	2	2	3	3
7 x 7.....	1	2	2	2	3	3	3	4	4
8 x 8.....	2	2	3	3	3	4	4	5	5
9 x 9.....	2	3	3	4	4	5	5	6	6
10 x 10.....	3	3	4	5	5	6	7	7	8
11 x 11.....	3	4	5	6	6	7	8	9	10
12 x 12.....	4	5	6	7	8	9	10	11	12
13 x 13.....	5	6	7	8	9	10	11	12	14
14 x 14.....	5	7	8	9	10	12	13	14	16
15 x 15.....	6	8	9	10	12	14	15	16	18
16 x 16.....	7	9	10	12	14	15	17	19	20
17 x 17.....	8	10	12	13	15	17	19	21	23
18 x 18.....	9	11	13	15	17	19	22	24	26
19 x 19.....	10	12	14	17	19	22	24	26	29
20 x 20.....	11	13	16	19	21	24	27	29	32
21 x 21.....	12	15	18	21	24	26	29	32	35
22 x 22.....	13	16	19	23	26	29	32	35	39
23 x 23.....	14	18	21	25	28	32	35	39	42
24 x 24.....	15	19	23	27	31	35	38	42	46
25 x 25.....	17	21	25	29	33	38	42	46	50
26 x 26.....	18	23	27	32	36	41	45	50	54
27 x 27.....	19	24	29	34	39	44	49	53	58
28 x 28.....	21	26	31	37	42	47	52	57	62
29 x 29.....	22	28	34	39	45	50	56	62	67
30 x 30.....	24	30	36	42	48	54	60	66	72

TABLE 3.—*Deduction for squared defects—Continued*

[20 per cent deducted for kerf from solid board-foot contents]

End-dimensions, inches	Length of defect—feet							
	13	14	15	16	17	18	19	20
	Contents—board feet in tens							
2 x 2.....	0.5	0.5	0.5	0.5	0.5	0.5	0.5	0.5
3 x 3.....	1	1	1	1	1	1	1	1
4 x 4.....	1	1	2	2	2	2	2	2
5 x 5.....	2	2	2	3	3	3	3	3
6 x 6.....	3	3	4	4	4	4	5	5
7 x 7.....	4	5	5	5	6	6	6	7
8 x 8.....	6	6	6	7	7	8	8	9
9 x 9.....	7	8	8	9	9	10	10	11
10 x 10.....	9	9	10	11	11	12	13	13
11 x 11.....	10	11	12	13	14	15	15	16
12 x 12.....	12	13	14	15	16	17	18	19
13 x 13.....	15	16	17	18	19	20	21	23
14 x 14.....	17	18	20	21	22	24	25	26
15 x 15.....	20	21	22	24	26	27	28	30
16 x 16.....	22	24	26	27	29	31	32	34
17 x 17.....	25	27	29	31	33	35	37	39
18 x 18.....	28	30	32	35	37	39	41	43
19 x 19.....	31	34	36	39	41	43	46	48
20 x 20.....	35	37	40	43	45	48	51	53
21 x 21.....	38	41	44	47	50	53	56	59
22 x 22.....	42	45	48	52	55	58	61	65
23 x 23.....	46	49	53	56	60	63	67	71
24 x 24.....	50	54	58	61	65	69	73	77
25 x 25.....	54	58	63	67	71	75	79	83
26 x 26.....	59	63	68	72	77	81	86	90
27 x 27.....	63	68	73	78	83	87	92	97
28 x 28.....	68	73	78	84	89	94	99	105
29 x 29.....	73	78	84	90	95	101	107	112
30 x 30.....	78	84	90	96	102	108	114	120

TABLE 3.—*Deduction for squared defects—Continued*

[30 per cent deducted for kerf from solid board-foot contents]

End dimensions, inches	Length of defect—feet															
	21	22	23	24	25	26	27	28	29	30	31	32	34	35	36	40
	Contents—board feet in tens															
2 x 2.....	0.5	0.5	0.5	0.5	0.5	0.5	0.5	1	1	1	1	1	1	1	1	1
3 x 3.....	1	1	1	1	2	2	2	2	2	2	2	2	2	2	2	2
4 x 4.....	2	2	2	3	3	3	3	3	3	3	3	3	3	4	4	4
5 x 5.....	4	4	4	4	4	4	4	4	5	5	5	5	5	6	6	6
6 x 6.....	5	5	6	6	6	6	6	7	7	7	7	8	8	9	9	10
7 x 7.....	7	7	8	8	8	8	9	9	9	10	10	10	11	12	12	13
8 x 8.....	9	9	10	10	11	11	12	12	12	13	13	14	15	15	16	17
9 x 9.....	11	12	12	13	14	14	15	15	16	16	17	17	18	19	21	22
10 x 10.....	14	15	15	16	17	17	18	19	19	20	21	21	23	24	25	27
11 x 11.....	17	18	19	19	20	21	22	23	23	24	25	26	27	29	31	32
12 x 12.....	20	21	22	23	24	25	26	27	28	29	30	31	33	35	36	38
13 x 13.....	24	25	26	27	28	29	30	32	33	34	35	36	38	41	43	45
14 x 14.....	27	29	30	31	33	34	35	37	38	39	41	42	44	47	50	52
15 x 15.....	32	33	34	36	38	39	40	42	44	45	46	48	51	54	57	60
16 x 16.....	36	38	39	41	43	44	46	48	49	51	53	55	58	61	65	68
17 x 17.....	40	42	44	46	48	50	52	54	56	58	60	62	66	69	73	77
18 x 18.....	45	48	50	52	54	56	58	60	63	65	67	69	73	78	82	86
19 x 19.....	51	53	55	58	60	63	65	67	70	72	75	77	82	87	91	96
20 x 20.....	56	59	61	64	67	69	72	75	77	80	83	85	91	96	101	107
21 x 21.....	62	65	68	71	74	76	79	82	85	88	91	94	100	106	112	118
22 x 22.....	68	71	74	77	81	84	87	90	94	97	100	108	110	116	123	130
23 x 23.....	74	78	81	85	88	92	95	99	102	106	109	113	120	127	134	141
24 x 24.....	81	84	88	92	96	100	104	108	111	115	119	123	131	138	146	154
25 x 25.....	88	92	96	100	104	108	112	117	121	125	129	133	142	150	158	167
26 x 26.....	95	99	104	108	113	117	122	126	131	135	140	144	153	162	171	180
27 x 27.....	102	107	112	117	122	126	131	136	141	146	151	156	165	175	185	194
28 x 28.....	110	115	120	125	131	136	141	146	152	157	162	167	178	188	199	209
29 x 29.....	118	123	129	135	140	146	151	157	163	168	174	179	191	202	213	224
30 x 30.....	126	132	138	144	150	156	162	168	174	180	186	192	204	216	228	240

TABLE 4.—Solid cubic contents of logs

Length, feet	Average middle diameter (in inches)																		
	3	4	5	6	7	8	9	10	11	12	13	14	15	16	17	18	19	20	
	Contents (in cubic feet)																		
4	0.25	0.25	0.5	1	1	1	2	2	3	3	4	4	5	6	6	7	8	9	
5	.25	.5	.5	1	1	2	2	3	3	4	5	5	6	7	8	9	10	11	
6	.25	.5	1	1	2	2	3	3	4	5	6	6	7	8	9	11	12	13	
7	.25	.5	1	1	2	2	3	4	4	5	6	7	9	10	11	12	14	15	
8	.5	.5	1	1	2	2	3	4	4	5	6	7	9	10	11	13	14	16	
9	.5	1	1	1	2	2	3	4	5	6	7	8	10	11	13	14	16	18	
10	.5	1	1	1	2	3	3	4	5	6	7	8	9	11	12	14	16	20	
11	.5	1	1	1	2	3	4	5	6	7	9	10	12	13	15	17	19	22	
12	.5	1	1	2	2	3	4	5	7	8	9	11	13	15	17	19	21	24	
13	.5	1	2	2	3	3	5	6	7	9	10	12	14	16	18	20	23	26	
14	.5	1	2	2	3	4	5	6	8	9	11	13	15	17	20	22	25	28	
15	.5	1	2	2	3	4	5	7	8	10	12	14	16	18	21	24	27	30	
16	1	1	2	2	3	4	6	7	9	11	13	15	17	20	22	25	28	32	
17	1	1	2	2	3	5	6	8	9	11	13	16	18	21	24	27	30	35	
18	1	2	2	4	5	6	8	10	12	14	17	19	22	25	28	32	35	39	
19	1	2	3	4	5	7	8	10	13	15	18	20	23	27	30	34	37	41	
20	1	2	3	4	6	7	9	11	13	16	18	21	25	28	32	35	39	44	
21	1	2	3	4	6	7	9	11	14	16	19	22	26	29	33	37	41	46	
22	1	2	3	4	6	8	10	12	15	17	20	24	27	31	35	39	43	48	
23	1	2	3	5	6	8	10	13	15	18	21	25	28	32	36	41	45	50	
24	1	2	3	5	6	8	11	13	16	19	22	26	29	34	38	42	47	52	
25	1	2	3	5	7	9	11	14	16	20	23	27	31	35	39	44	49	55	
26				5	7	9	11	14	17	20	24	28	32	36	41	46	51	57	
27				5	7	9	12	15	18	21	25	29	33	38	43	48	53	59	
28				6	7	10	12	15	18	22	26	30	34	39	44	49	55	61	
29				6	8	10	13	16	19	23	27	31	36	40	46	51	57	63	
30				6	8	10	13	16	20	24	28	32	37	42	47	53	59	65	
31				6	8	11	14	17	20	24	29	33	38	43	49	55	61	68	
32				6	9	11	14	17	21	25	29	34	39	45	50	57	63	70	
33				6	9	12	15	18	22	26	30	35	40	46	52	58	65	72	
34				7	9	12	15	19	22	27	31	36	42	47	54	60	67	74	
35				7	9	12	15	19	23	27	32	37	43	49	55	62	69	76	
36				7	10	13	16	20	24	28	33	38	44	50	57	64	71	79	
37				7	10	13	16	20	24	29	34	40	45	52	58	65	73	81	
38				7	10	13	17	21	25	30	35	41	47	53	60	67	75	83	
39				8	10	14	17	21	26	31	36	42	48	54	61	69	77	85	
40				8	11	14	18	22	26	31	37	43	49	56	63	71	79	87	

TABLE 4.—Solid cubic contents of logs—Continued

Length, feet	Average middle diameter (in inches)																			
	21	22	23	24	25	26	27	28	29	30	31	32	33	34	35	36	37	38	39	40
Contents (in cubic feet)																				
4.....	10	11	12	13	14	15	16	17	18	20	21	22	24	25	27	28	30	32	33	35
5.....	12	13	14	16	17	18	20	21	23	25	26	28	30	32	33	35	37	39	41	44
6.....	14	16	17	19	20	22	24	26	28	29	31	34	36	38	40	42	45	47	50	52
7.....	17	18	20	22	24	26	28	30	32	34	37	39	42	44	47	49	52	55	58	61
8.....	19	21	23	25	27	29	32	34	37	39	42	45	48	50	53	57	60	63	66	70
9.....	22	24	26	28	31	33	36	38	41	44	47	50	53	57	60	64	67	71	75	79
10.....	24	26	29	31	34	37	40	43	46	49	52	56	59	63	67	71	75	79	83	87
11.....	26	29	32	35	37	41	44	47	50	54	58	61	65	69	73	78	82	87	91	96
12.....	29	32	35	38	41	44	48	51	55	59	63	67	71	76	80	85	90	95	100	105
13.....	31	34	38	41	44	48	52	56	60	64	68	73	77	82	87	92	97	102	108	113
14.....	34	37	40	44	48	52	56	60	64	69	73	78	83	88	94	99	105	110	116	122
15.....	36	40	43	47	51	55	60	64	69	74	79	84	89	95	100	106	112	118	124	131
16.....	38	42	46	50	55	59	64	68	73	79	84	89	95	101	107	113	119	126	133	140
17.....	41	45	49	53	58	63	68	73	78	83	89	95	101	107	114	120	127	134	141	148
18.....	43	48	52	57	61	66	72	77	83	88	94	101	107	113	120	127	134	142	149	157
19.....	46	50	55	60	65	70	76	81	87	93	100	106	113	120	127	134	142	150	158	166
20.....	48	53	58	63	68	74	80	86	92	98	105	112	119	126	134	141	149	158	166	175
21.....	51	55	61	66	72	77	83	90	96	103	110	117	125	132	140	148	157	165	174	183
22.....	53	58	63	69	75	81	87	94	101	108	115	123	131	139	147	156	164	173	183	192
23.....	55	61	66	72	78	85	91	98	105	113	121	128	137	145	154	163	172	181	191	201
24.....	58	63	69	75	82	88	95	103	110	118	126	134	143	151	160	170	179	189	199	209
25.....	60	66	72	79	85	92	99	107	115	123	131	140	148	158	167	177	187	197	207	218
26.....	63	69	75	82	89	96	103	111	119	128	136	145	154	164	174	184	194	205	216	227
27.....	65	71	78	85	92	100	107	115	124	133	142	151	160	170	180	191	202	213	224	236
28.....	67	74	81	88	95	103	111	120	128	137	147	156	166	177	187	198	209	221	232	244
29.....	70	77	84	91	99	107	115	124	133	142	152	162	172	183	194	205	217	228	241	253
30.....	72	79	87	94	102	111	119	128	138	147	157	168	178	189	200	212	224	236	249	262
31.....	75	82	89	97	106	114	123	133	142	152	162	173	184	195	207	219	231	244	257	271
32.....	77	84	92	101	109	118	127	137	147	157	168	179	190	202	214	226	239	252	265	279
33.....	79	87	95	104	112	122	131	141	151	162	173	184	196	208	220	233	246	260	274	288
34.....	82	90	98	107	116	125	135	145	156	167	178	190	202	214	227	240	254	268	282	297
35.....	84	92	101	110	119	129	139	150	161	172	183	195	208	221	234	247	261	276	290	305
36.....	87	95	104	113	123	133	143	154	165	177	189	201	214	227	241	254	269	284	299	314
37.....	89	98	107	116	126	136	147	158	170	182	194	207	220	233	247	262	276	291	307	323
38.....	91	100	110	119	130	140	151	162	174	187	199	212	226	240	254	269	284	299	315	332
39.....	94	103	113	123	133	144	155	167	179	191	204	218	232	246	261	276	291	307	324	340
40.....	96	106	115	126	136	147	159	171	183	196	210	223	238	252	267	283	299	315	332	349

TABLE 4.—Solid cubic contents of logs—Continued

Length, feet	Average middle diameter (in inches)																			
	41	42	43	44	45	46	47	48	49	50	51	52	53	54	55	56	57	58	59	60
	Contents (in cubic feet)																			
4	37	38	40	42	44	46	48	50	52	55	57	59	61	64	66	68	71	73	76	79
5	46	48	50	53	55	58	60	63	65	68	71	74	77	80	82	86	89	92	95	98
6	55	58	61	63	66	69	72	75	79	82	85	88	92	95	99	103	106	110	114	118
7	64	67	71	74	77	81	84	88	92	95	99	103	107	111	115	120	124	128	133	137
8	73	77	81	84	88	92	96	101	105	109	113	118	123	127	132	137	142	147	152	157
9	83	87	91	95	99	104	108	113	118	123	128	133	138	143	148	154	159	165	171	177
10	92	96	101	106	110	115	120	126	131	136	142	147	153	159	165	171	177	183	190	196
11	101	106	111	116	121	127	133	138	144	150	156	162	169	175	181	188	195	202	209	216
12	110	115	121	127	133	138	145	151	157	164	170	177	184	191	198	205	213	220	228	236
13	119	125	131	137	144	150	157	163	170	177	184	192	199	207	214	222	230	239	247	255
14	128	135	141	148	155	162	169	176	183	191	199	206	214	223	231	239	248	257	266	275
15	138	144	151	158	166	173	181	188	196	205	213	221	230	239	247	257	266	275	285	295
16	147	154	161	169	177	185	193	201	210	218	227	236	245	254	264	274	284	294	304	314
17	156	164	171	180	188	196	205	214	223	232	241	251	260	270	280	291	301	312	323	334
18	165	173	182	190	199	208	217	226	236	245	255	265	276	286	297	308	319	330	342	353
19	174	183	192	201	210	219	229	239	249	259	270	280	291	302	313	325	337	349	361	373
20	183	192	202	211	221	231	241	251	262	273	284	295	306	318	330	342	354	367	380	393
21	193	202	212	222	232	242	253	264	275	286	298	310	322	334	346	359	372	385	399	412
22	202	212	222	232	243	254	265	276	288	300	312	324	337	350	363	376	390	404	418	432
23	211	221	232	243	254	265	277	289	301	314	326	339	352	366	379	393	408	422	437	453
24	220	231	242	253	265	277	289	302	314	327	340	354	368	382	396	411	425	440	456	471
25	229	241	252	264	276	289	301	314	327	341	355	369	383	398	412	428	443	459	475	491
26	238	250	262	275	287	300	313	327	340	355	369	383	398	414	429	445	461	477	494	511
27	248	260	272	285	298	312	325	339	354	368	383	398	414	429	445	462	478	495	513	530
28	257	269	282	296	309	323	337	352	367	382	397	413	429	445	462	479	496	514	532	550
29	266	279	292	306	320	335	349	364	380	395	411	428	444	461	478	496	514	532	551	569
30	275	289	303	317	331	346	361	377	393	409	426	442	460	477	495	513	532	550	570	589
31	284	298	313	327	342	358	373	390	406	423	440	457	475	493	511	530	549	569	589	609
32	293	308	323	338	353	369	386	402	419	436	454	472	490	509	528	547	567	587	608	628
33	303	317	333	348	364	381	398	415	432	450	468	487	506	525	544	564	585	605	627	648
34	312	327	343	359	376	392	410	427	445	464	482	501	521	541	561	582	603	624	646	668
35	321	337	353	370	387	404	422	440	458	477	497	516	536	557	577	599	620	642	665	687
36	330	346	363	380	398	415	434	452	471	491	511	531	552	573	594	616	638	661	683	707
37	339	356	373	391	409	427	446	465	485	505	525	546	567	588	610	633	656	679	702	726
38	348	366	383	401	420	439	458	478	498	518	539	560	582	604	627	650	673	697	721	746
39	358	375	393	412	431	450	470	490	511	532	553	575	598	620	643	667	691	716	740	766
40	367	385	403	422	442	462	482	503	524	545	567	590	613	636	660	684	709	734	759	785

TABLE 5.—Board-foot contents of standard sizes of timber

End dimensions, inches	Length of timber—feet								
	10	12	14	16	18	20	22	24	
	Contents—board feet								
1 x 2	2	1 $\frac{3}{8}$	2	2 $\frac{1}{8}$	2 $\frac{3}{8}$	3	3 $\frac{1}{8}$	3 $\frac{3}{8}$	4
	3	2 $\frac{1}{2}$	3	3 $\frac{1}{2}$	4	4 $\frac{1}{2}$	5	5 $\frac{1}{2}$	6
	4	3 $\frac{1}{8}$	4	4 $\frac{1}{8}$	5 $\frac{1}{8}$	6	6 $\frac{3}{8}$	7 $\frac{1}{8}$	8
	5	4 $\frac{1}{8}$	5	5 $\frac{1}{8}$	6 $\frac{1}{8}$	7 $\frac{1}{2}$	8 $\frac{1}{8}$	9 $\frac{1}{8}$	10
	6	5	6	7	8	9	10	11	12
	7	5 $\frac{5}{8}$	7	8 $\frac{1}{8}$	9 $\frac{1}{8}$	10 $\frac{1}{2}$	11 $\frac{3}{8}$	12 $\frac{5}{8}$	14
	8	6 $\frac{1}{8}$	8	9 $\frac{1}{8}$	10 $\frac{1}{8}$	12	13 $\frac{1}{8}$	14 $\frac{3}{8}$	16
	10	8 $\frac{1}{8}$	10	11 $\frac{3}{8}$	13 $\frac{1}{8}$	15	16 $\frac{3}{8}$	18 $\frac{1}{8}$	20
	12	10	12	14	16	18	20	22	24
	14	11 $\frac{3}{8}$	14	16 $\frac{3}{8}$	18 $\frac{3}{8}$	21	23 $\frac{1}{8}$	25 $\frac{3}{8}$	28
	16	13 $\frac{1}{8}$	16	18 $\frac{3}{8}$	21 $\frac{1}{8}$	24	26 $\frac{3}{8}$	29 $\frac{1}{8}$	32
18	15	18	21	24	27	30	33	36	
20	16 $\frac{3}{8}$	20	23 $\frac{1}{8}$	26 $\frac{3}{8}$	30	33 $\frac{1}{8}$	36 $\frac{3}{8}$	40	
1 $\frac{1}{4}$ x 4	4	4 $\frac{1}{8}$	5	5 $\frac{5}{8}$	6 $\frac{3}{8}$	7 $\frac{1}{2}$	8 $\frac{1}{8}$	9 $\frac{1}{8}$	10
	6	6 $\frac{1}{4}$	7 $\frac{1}{2}$	8 $\frac{3}{4}$	10	11 $\frac{1}{4}$	12 $\frac{1}{2}$	13 $\frac{3}{4}$	15
	8	8 $\frac{1}{2}$	10	11 $\frac{1}{2}$	13 $\frac{1}{2}$	15	16 $\frac{3}{4}$	18 $\frac{1}{2}$	20
	10	10	12 $\frac{1}{2}$	14 $\frac{1}{2}$	16 $\frac{3}{4}$	18 $\frac{3}{4}$	20 $\frac{5}{8}$	22 $\frac{1}{2}$	25
12	12 $\frac{1}{2}$	15	17 $\frac{1}{2}$	20	22 $\frac{1}{2}$	25	27 $\frac{1}{2}$	30	
1 $\frac{1}{2}$ x 4	4	5	6	7	8	9	10	11	12
	6	7 $\frac{1}{2}$	9	10 $\frac{1}{2}$	12	13 $\frac{1}{2}$	15	16 $\frac{1}{2}$	18
	8	10	12	14	16	18	20	22	24
	10	12 $\frac{1}{2}$	15	17 $\frac{1}{2}$	20	22 $\frac{1}{2}$	25	27 $\frac{1}{2}$	30
	12	15	18	21	24	27	30	33	36
2 x 3	3	5	6	7	8	9	10	11	12
	4	6 $\frac{2}{8}$	8	9 $\frac{1}{8}$	10 $\frac{2}{8}$	12	13 $\frac{1}{8}$	14 $\frac{2}{8}$	16
	6	10	12	14	16	18	20	22	24
	8	13 $\frac{1}{8}$	16	18 $\frac{2}{8}$	21 $\frac{1}{8}$	24	26 $\frac{2}{8}$	29 $\frac{1}{8}$	32
	10	16 $\frac{2}{8}$	20	23 $\frac{1}{8}$	26 $\frac{2}{8}$	30	33 $\frac{1}{8}$	36 $\frac{2}{8}$	40
	12	20	24	28	32	36	40	44	48
	14	23 $\frac{1}{8}$	28	32 $\frac{2}{8}$	37 $\frac{1}{8}$	42	46 $\frac{2}{8}$	51 $\frac{1}{8}$	56
16	26 $\frac{2}{8}$	32	37 $\frac{1}{8}$	42 $\frac{2}{8}$	48	53 $\frac{1}{8}$	58 $\frac{2}{8}$	64	
2 $\frac{1}{2}$ x 12	12	25	30	35	40	45	50	55	60
	14	29 $\frac{1}{8}$	35	40 $\frac{2}{8}$	46 $\frac{2}{8}$	52 $\frac{1}{2}$	58 $\frac{1}{8}$	64 $\frac{1}{8}$	70
	16	33 $\frac{1}{8}$	40	46 $\frac{2}{8}$	53 $\frac{1}{8}$	60	66 $\frac{2}{8}$	73 $\frac{1}{8}$	80
3 x 4	4	10	12	14	16	18	20	22	24
	6	15	18	21	24	27	30	33	36
	8	20	24	28	32	36	40	44	48
	10	25	30	35	40	45	50	55	60
	12	30	36	42	48	54	60	66	72
	14	35	42	49	56	63	70	77	84
	16	40	48	56	64	72	80	88	96

TABLE 5.—Board-foot contents of standard sizes of timber—Con.

End dimensions, inches	Length of timber—feet							
	10	12	14	16	18	20	22	24
	Contents—board feet							
4 x 4.....	18½	16	18½	21½	24	26½	29½	32
6.....	20	24	28	32	36	40	44	48
8.....	26½	32	37½	42½	48	53½	58½	64
10.....	33½	40	46½	53½	60	66½	73½	80
12.....	40	48	56	64	72	80	88	96
14.....	46½	56	65½	74½	84	93½	102½	112
5 x 8.....	33½	40	46½	53½	60	66½	73½	80
6 x 6.....	30	36	42	48	54	60	66	72
8.....	40	48	56	64	72	80	88	96
10.....	50	60	70	80	90	100	110	120
12.....	60	72	84	96	108	120	132	144
14.....	70	84	98	112	126	140	154	168
16.....	80	96	112	128	144	160	176	192
8 x 8.....	53½	64	74½	85½	96	106½	117½	128
10.....	66½	80	93½	106½	120	133½	146½	160
12.....	80	96	112	128	144	160	176	192
14.....	93½	112	130½	149½	168	186½	205½	224
10 x 10.....	83½	100	116½	133½	150	166½	183½	200
12.....	100	120	140	160	180	200	220	240
14.....	116½	140	163½	186½	210	233½	256½	280
16.....	133½	160	186½	213½	240	266½	293½	320
12 x 12.....	120	144	168	192	216	240	264	288
14.....	140	168	196	224	252	280	308	336
16.....	160	192	224	256	288	320	352	384
14 x 14.....	163½	196	228½	261½	294	326½	359½	392
16.....	186½	224	261½	298½	336	373½	410½	448
18.....	210	252	294	336	378	420	462	504
16 x 16.....	213½	256	298½	341½	384	426½	469½	512
18.....	240	288	336	384	432	480	528	576
20.....	266½	320	373½	426½	480	533½	586½	640
18 x 18.....	270	324	378	432	486	540	594	648
20 x 20.....	333½	400	466½	533½	600	666½	733½	800
22 x 22.....	403½	484	564½	645½	726	806½	887½	968
24 x 24.....	480	576	672	768	864	960	1,056	1,152
26 x 26.....	563½	676	788½	901½	1,014	1,126½	1,239½	1,352
28 x 28.....	653½	784	914½	1,045½	1,176	1,306½	1,437½	1,568
30 x 30.....	750	900	1,050	1,200	1,350	1,500	1,650	1,800

TABLE 5.—Board-foot contents of standard sizes of timber—Con.

End dimensions, inches	Length of timber—feet					
	28	32	34	36	38	40
	Contents—board feet					
8 x 8.....	149½	170½	181½	192	202½	213½
10.....	186½	213½	228½	240	253½	266½
12.....	224	256	272	288	304	320
14.....	261½	298½	317½	336	354½	373½
10 x 10.....	233½	266½	283½	300	316½	333½
12.....	280	320	340	360	380	400
14.....	326½	373½	396½	420	443½	466½
16.....	373½	426½	453½	480	506½	533½
12 x 12.....	336	384	408	432	456	480
14.....	392	448	476	504	532	560
16.....	448	512	544	576	608	640
14 x 14.....	457½	522½	555½	588	620½	653½
16.....	522½	597½	634½	672	709½	746½
18.....	588	672	714	756	798	840
16 x 16.....	597½	682½	725½	768	810½	853½
18.....	672	768	816	864	912	960
20.....	746½	853½	906½	960	1,013½	1,066½
18 x 18.....	756	864	918	972	1,026	1,080
20 x 20.....	933½	1,066½	1,133½	1,200	1,266½	1,333½
22 x 22.....	1,129½	1,290½	1,371½	1,452	1,532½	1,613½
24 x 24.....	1,344	1,536	1,632	1,728	1,824	1,920
26 x 26.....	1,577½	1,802½	1,915½	2,028	2,140½	2,253½
28 x 28.....	1,829½	2,090½	2,221½	2,352	2,482½	2,613½
30 x 30.....	2,100	2,400	2,550	2,700	2,850	3,000

CONVERTING FACTORS

For convenience in preparing statistics, such as reports of timber cut and sold, and for price determinations in sales under regulation S-22 for products for which prices have not been established by the chief, it is necessary to convert other products than saw timber into feet board measure. Regional foresters will establish converting factors by forests for these purposes. It is often possible and desirable to establish a converting factor for all standard-gauge hewn ties cut on a given forest based on the size of the average tie; and similar factors are

often applicable to groups of sizes of telephone poles, piling, or posts. Standard conversion factors established by regional foresters will not be inconsistent with Table 6, which will be used in the absence of approved local tables:

TABLE 6.—Standard converting factors

Product	Assumed dimensions	Equivalent in board feet
Cord, standard.....	4 by 4 by 8 feet.....	500
Cord, long.....	4 by 5 by 8 feet.....	625
Cord, shingle bolts.....	4 by 4 by 8 feet.....	600
Cord, small material (averaging less than 5 inches middle diameter in the round).....	do.....	333½
Cord, short.....	4 by 3 by 8 feet.....	375
Cord, short, small material.....	do.....	250
Load (small, irregular pieces that can not be ricked).....	4 by 4 by 8 feet.....	333½
Tie, standard.....	7 by 9 inches by 8 feet.....	35
Do.....	7 by 8 inches by 8 feet.....	30
Do.....	6 by 6 inches by 8 feet.....	20
Tie, narrow gauge.....	7 by 8 inches by 6½ feet.....	25
Do.....	6 by 7 inches by 6½ feet.....	20
Do.....	6 by 6 inches by 6 feet.....	15
Pole (telephone) or piling.....	8 inches by 45 feet.....	200
Do.....	8 inches by 40 feet.....	150
Do.....	8 inches by 35 feet.....	100
Do.....	7 inches by 60 feet.....	280
Do.....	7 inches by 50 feet.....	200
Do.....	7 inches by 40 feet.....	100
Do.....	7 inches by 35 feet.....	80
Do.....	7 inches by 30 feet.....	60
Do.....	7 inches by 25 feet.....	50
Do.....	5 inches by 25 feet.....	80
Cubic foot.....	13.6 inches by 1 foot.....	6
Linear foot.....	10 inches by 1 foot.....	3
Linear foot (long piling).....	80 to 125 feet by 6 inches.....	5½
Derrick pole.....	7 inches by 30 feet.....	60
Derrick set (11 pieces).....		480
Post, fence.....	6 inches by 7 feet.....	7
Do.....	5 inches by 7 feet.....	5
Post, split.....	18 inches circumference by 7 feet.....	6
Brace, fence.....	4 inches by 6 feet.....	2
Stake, fence.....	3 inches by 5 feet.....	1
Stay, fence.....	2 inches by 6 feet.....	1
Rail, fence (split).....	20 inches circumference by 16 feet.....	15
Pole, fence.....	4 inches by 20 feet.....	10
Pole (12 pieces).....	4 inches by 16 feet.....	100
Pole, converter.....	4 inches by 20 feet.....	10
Prop.....	6 inches by 10 feet.....	10
Lagging (6 pieces).....	3 inches by 6 feet.....	10

TABLE 7.—*Converting factors—Chestnut telephone poles*

[Based upon taper measurements]

Top diameter inside bark, inches	Length of pole, feet											
	20	25	30	35	40	45	50	55	60	65	70	75
	Contents—board feet in tens											
5.....	1	3	4	6	8	10	13	16	20	25	31	39
6.....	2	4	6	8	10	13	16	20	25	31	39	48
7.....	4	5	7	10	13	16	20	25	31	39	47	58
8.....	5	7	9	12	16	20	25	31	38	47	56	67
9.....			11	15	19	25	30	38	46	55	65	77
10.....			13	18	24	30	37	45	54	63	75	89
11.....							45	52	62	72	85	101
12.....							53	61	71	82	96	114

TABLE 8.—*Areas of circles*

Diameter, inches	Area	Diameter, inches	Area	Diameter, inches	Area	Diameter, inches	Area
1.....	Sq. ft. 0.01	21.....	2.41	41.....	9.17	61.....	20.29
2.....	.02	22.....	2.64	42.....	9.62	62.....	20.97
3.....	.05	23.....	2.89	43.....	10.08	63.....	21.65
4.....	.09	24.....	3.14	44.....	10.56	64.....	22.34
5.....	.14	25.....	3.41	45.....	11.04	65.....	23.04
6.....	.20	26.....	3.69	46.....	11.54	66.....	23.76
7.....	.27	27.....	3.98	47.....	12.05	67.....	24.48
8.....	.35	28.....	4.28	48.....	12.57	68.....	25.22
9.....	.44	29.....	4.59	49.....	13.10	69.....	25.97
10.....	.55	30.....	4.91	50.....	13.64	70.....	26.73
11.....	.66	31.....	5.24	51.....	14.19	71.....	27.49
12.....	.79	32.....	5.59	52.....	14.75	72.....	28.27
13.....	.92	33.....	5.94	53.....	15.32	73.....	29.07
14.....	1.07	34.....	6.31	54.....	15.90	74.....	29.87
15.....	1.23	35.....	6.68	55.....	16.50	75.....	30.68
16.....	1.40	36.....	7.07	56.....	17.10	76.....	31.50
17.....	1.58	37.....	7.47	57.....	17.72	77.....	32.34
18.....	1.77	38.....	7.88	58.....	18.35	78.....	33.18
19.....	1.97	39.....	8.30	59.....	18.99	79.....	34.04
20.....	2.18	40.....	8.73	60.....	19.63	80.....	34.91

TABLE 9.—Taper

[For scaling in maximum lengths of 16 feet]

Total length, feet	Log length			
	Butt log	Second log	Third log	Top log
18	10'			8'
Increase	1"			0"
20	10'			10'
Increase	1"			0"
22	12'			10'
Increase	1"			0"
24	12'			12'
Increase	1"			0"
26	14'			12'
Increase	1"			0"
28	14'			14'
Increase	2"			0"
30	16'			14'
Increase	2"			0"
32	16'			16'
Increase	2"			0"
34	12'	12'		10'
Increase	3"	1"		0"
36	12'	12'		12'
Increase	3"	1"		0"
38	14'	12'		12'
Increase	3"	1"		0"
40	16'	12'		12'
Increase	3"	1"		0"
42	14'	14'		14'
Increase	3"	1"		0"
44	16'	16'		12'
Increase	3"	1"		0"
46	16'	16'		14'
Increase	4"	2"		0"
48	16'	16'		16'
Increase	4"	2"		0"
50	14'	12'	12'	12'
Increase	4"	3"	1"	0"
52	16'	12'	12'	12'
Increase	4"	3"	1"	0"
54	16'	14'	12'	12'
Increase	5"	3"	1"	0"
56	16'	16'	12'	12'
Increase	5"	3"	1"	0"
58	16'	16'	14'	12'
Increase	5"	3"	2"	0"
60	16'	16'	14'	14'
Increase	5"	3"	2"	0"

Table 9 is intended to be used simply as a guide; the allowances for taper shown in this table should be varied to conform to the actual taper.

TABLE 10.—*Taper*

[For scaling in maximum lengths of 40 feet]

Total length, feet	Log length			
	Butt log	Second log	Third log	Top log
42	22'			20'
Increase	2"			0"
44	22'			22'
Increase	2"			0"
46	24'			22'
Increase	2"			0"
48	24'			24'
Increase	3"			0"
50	26'			24'
Increase	3"			0"
52	26'			26'
Increase	3"			0"
54	28'			26'
Increase	3"			0"
56	28'			28'
Increase	3"			0"
58	30'			28'
Increase	4"			0"
60	30'			30'
Increase	4"			0"
62	32'			30'
Increase	4"			0"
64	32'			32'
Increase	4"			0"
66	34'			32'
Increase	5"			0"
68	34'			34'
Increase	5"			0"
70	36'			34'
Increase	5"			0"
72	36'			36'
Increase	5"			0"
74	38'			36'
Increase	6"			0"
76	38'			38'
Increase	6"			0"
78	40'			38'
Increase	6"			0"
80	40'			40'
Increase	6"			0"
82	28'	28'		26'
Increase	7"	5"		6"
84	28'	28'		20"
Increase	8"	5"		

TABLE 10.—*Taper*—Continued

Total length, feet	Log length			
	Butt log	Second log	Third log	Top log
86	30'	28'	-----	28'
Increase	8"	5"	-----	0"
88	30'	30'	-----	28'
Increase	8"	5"	-----	0"
90	30'	30'	-----	30'
Increase	8"	6"	-----	0"
92	32'	30'	-----	30'
Increase	8"	6"	-----	0"
94	32'	32'	-----	30'
Increase	8"	6"	-----	0"
96	32'	32'	-----	32'
Increase	9"	6"	-----	0"
98	34'	32'	-----	32'
Increase	9"	6"	-----	0"
100	34'	34'	-----	32'
Increase	9"	6"	-----	0"

Table 10 is intended to be used simply as a guide; the allowances for taper shown should be varied to conform to the actual taper.

Purchaser, John Smith

Timber, Sale, 5-20-12 End Mark, Name

SPECIES Western Yellow Pine
8-200

Loc No.	Layers.	Fr. B. M.	Loc No.	Layers	Fr. B. M.	Loc No.	Layers.	Fr. B. M.		
50	1	16	40	21	12	35	5	41	14	60
	2	14	57	22	16	43		42	12	75
	3	12	53	23	16	24		43	16	53
	4	20	36	24	18	60		44	16	20
	5	16	⑥ 12	25	14	cull		45	14	8
	6	14	cull	26	12	⑦ 15		46	14	13
	7	16	6	27	16	37		47	12	cull
	8	16	⑧ 9	28	14	54		48	20	98
	9	12	25	29	16	75		49	16	⑨ 100
	10	14	57	30	16	87		50	18	49
	11	16	⑩ 60	31	14	18		51	14	57
	12	16	92	32	14	10		52	12	23
	13	14	10	33	12	10		53	16	10
	14	14	12	34	10	cull		54	16	12
	15	12	10	35	16	28		55	16	55
	16	14	⑪ 20	36	20	30		56	16	30
	17	16	18	37	14	⑫ 50		57	10	65
	18	16	21	38	12	42		58	14	46
	19	16	24	39	16	64		59	12	25
	20	18	cull	40	16	75		60	14	18
			562			757				817

5620

7570

8170

Scaled by Chas Brown
F.R.

SI-SAW TIMBER.

Where Scaled, At railroad landing No. 3. 6
 Compartment 2; Sec. 25; T. 5; R. 4E; Date 9-15, 1902

SPECIES

1-300

Log No.	LENGTH	FT. B. M.	Log No.	LENGTH	FT. B. M.	REMARKS.
5 61	16	37	5 81	12	15	Other Species are recorded on other pages or in other books.
62	16	59	82	14	18	
63	12	21	83	18	46	
64	16	16	84	16	78	
65	14	35	85	16	39	
66	18	67	86	14	cull	
67	18	95	87	20	105	
68	12	41	88	12	27	
69	12	9	89	12	50	
70	14	10	90	16	cull	
71	16	cull	91	16	53	
72	16	74	92	16	10	
73	14	49	93	14	17	
74	14	57	94	16	29	
75	20	24	95	12	8	
76	16	6	96	16	56	
77	16	30	97	14	49	
78	14	89	98	16	60	
79	12	57	99	16	cull	
80	12	36	100	14	36	
		812			696	

8120

6960

36440

110750

147190

TOTAL, THIS PAGE

BROUGHT FORWARD.

TOTAL SINCE LAST REPORT.

REPORTED TO 9/1/12. 560,420

TOTAL TO 9/15/12. 707,610

PURCHASER Baise-Payette Lumber Co
 TIMBER SALE 6-9-23

SPECIES YPDF - AF			SPECIES YPDF - AF			SPECIES YP	
Log No.	Length	Feet B. M.	Log No.	Length	Feet B. M.	Log No.	Length
1	12	21	26	18	102	51	16 38
2	20	25	27	16	10	52	16
3	16	30	28	16	14	53	16
4	14	64	29	16	92	54	18
5	16	8	30	16	50	55	16
6	16	4	31	14	81	56	16
7	16	26	32	16	29	57	16 28
8	16	75	33	16	C	58	16 33
9	18	40	34	16	30	59	18
10	14	44	35	16	30	60	18 20
11	16	38	36	16	33	61	16 25
12	16	38	37	14	98	62	16 11
13	16	12	38	16	20	63	16 30
14	16	18	39	16	11	64	16 21
15	16	8	40	16	25	65	14
16	16	26	41	18	10	66	16 21
17	16	14	42	14	5	67	16 6
18	16	46	43	12	21	68	16 14
19	16	46	44	18	36	69	16 8
20	16	40	45	16	18	70	16 8
21	12	9	46	20	23	71	16 16
22	18	20	47	16	30	72	16 58
23	16	112	48	16	38	73	16 11
24	18	20	49	16	20	74	14 3
25	18	8	50	16	34	75	16 3
		32			774 56		3540
TOTAL BY SPECIES	AF						
	DF	320			560		
	YP	7200			7740		3540

Compartment 2 Sec. 16 Twp. 3-S, R. 14 E W M

Log No.	Log Grade	Length	Diameter	CONTENTS BY SPECIES					Defects, Kind, Amount Destroyed, Overlengths
				DF	WH	RC	WF	—	
40		40	18	62					
2		40	28	155					
3		38	40	270					60-R & P.R.
4		32	20			56			
5		28	16		28				
6		38	22		50				38-R
7		40	17				58		
8		24	18			32			
9		40	40	318					
41	0	36	26		121				
1		40	19		68				
2		34	23		83				
3		20	16			20			
4		40	22	80					12-S
5		38	16				45		
6		36	22		80				3-S
7		24	24			61			
8		40	27	144					
9		38	36		237				
42	0	24	18			32			
1		40	16				43		
2		36	17				48		
3		28	19			42			
4		34	20			66			
5		22	15		20				
6		40	21	80					5-R
7		30	17		35				
8		40	21	85					
9		40	35	238					
43	0	28	11				12		
Total Scale				1432	722	309	206		Scaled by:
Number of Logs				9	9	7	5		G.E.S.

E-SAW TIMBER

Where scaled On Cars Date Feb. 26, 1926

No.	Log Grade	Length	Diameter	CONTENTS BY SPECIES					Defects, Kind, Amount Deducted, Overlengths
				DF	WH	RC	WF	—	
43	1	40	17		40				13-R
	2	26	16			26			
	3	36	24		101				
	4	40	28		140				15-S, R
	5	18	16				18		
	6	16	19			24			
	7	40	28	100					55-R
	8	36	24		90				11-S
	9	32	16			16			16-R
44	0	24	19		30				6-S
	1	30	24	76					
	2	32	26	90					10-P, R
	3	38	19			35			30-R
	4	40	18				62		
	5	40	38	200					83-R
	6	30	30		123				
	7	24	19			36			
	8	16	18			20			1-Breaks
	9	20	21			30			8-R
45	0	40	19		68				
	1	38	41	290					27-R & P, R
	2	18	24		45				
	3	40	30	165					9-R
	4	36	19		60				1-Split
	5	28	30		100				15-S
	6	18	21			24			
	7	28	16			26			2-R
	8	36	24	90					11-P, R
	9	20	38	100					33-R
46	0	26	19		30				9-S
Total Scale				1111	827	237	80		Scaled by:
Number of Logs				8	11	9	2		G.E.S.

SAMPLE PAGE 4—FORM 651—SAW TIMBER, SUMMARY SHEET

Purchaser..... *S.no. qualmie Logging Co.*..... *5/16-26*.....

Scaled by..... <i>G.F.S.</i>		Scale B.F.			No. of Pieces		
Forward	Cutting Report No.	D.F.	Hem.	Cedar	D.F.	Hem.	Cedar
<i>Page No. 1</i>		<i>1814</i>	<i>611</i>	<i>413</i>	<i>20</i>	<i>6</i>	<i>4</i>
<i>2</i>		<i>741</i>	<i>1238</i>	<i>943</i>	<i>6</i>	<i>18</i>	<i>6</i>
<i>3</i>		<i>2142</i>	<i>38</i>	<i>126</i>	<i>28</i>	<i>1</i>	<i>1</i>
<i>4</i>		<i>1181</i>	<i>247</i>	<i>672</i>	<i>12</i>	<i>7</i>	<i>11</i>
<i>5</i>		<i>1641</i>	<i>283</i>	<i>68</i>	<i>23</i>	<i>6</i>	<i>1</i>
<i>6</i>		<i>3047</i>			<i>30</i>		
<i>7</i>		<i>1261</i>	<i>785</i>		<i>18</i>	<i>12</i>	
<i>8</i>		<i>1946</i>		<i>124</i>	<i>27</i>		<i>3</i>
<i>9</i>		<i>1876</i>	<i>716</i>	<i>524</i>	<i>13</i>	<i>9</i>	<i>8</i>
<i>10</i>		<i>426</i>	<i>1243</i>	<i>691</i>	<i>5</i>	<i>15</i>	<i>10</i>
<i>Total Reported</i>	<i>1</i>	<i>16075</i>	<i>5161</i>	<i>3561</i>	<i>182</i>	<i>74</i>	<i>44</i>
<i>8/31-25</i>							

11	916	738	411	13	11	6
12	1281	413	940	14	4	12
13	2213	961		21	9	
14	1731	413	624	19	4	7
15	2431			30		
16	413	817	942	7	12	11
Total 9/30-26	8985	3342	2917	104	40	36
Previously Re-ported	16075	5161	3561	182	74	44
Total Reported 9/30-26	225060	8503	6478	286	114	80
17	2816	75	234	23	1	6
18	1438	641	285	16	9	5
19	1900	218	613	18	4	8
Total 10/31-26	6154	934	1132	57	14	19
Previously Re-ported	225060	8503	6478	286	114	80
Total Reported 10/31-26	31214	9437	7610	343	128	99
Carried forward						

PURCHASER Leighton & Cole
 TIMBER SALE 12-30-22

SPECIES - <i>Pinus strobus</i>			SPECIES - <i>Pinus strobus</i>			SPECIES -		
PK	Length	Diag. H.	PK	Length	Diag. H.	PK	Length	Diag. H.
1	2	4	32		6	31	25	
2	1		17	24		32	15	
3	1		23	22		33	18	
4	1		17	18		34	17	
5	1		17	5		35	17	
6	1		17	5		36	17	
7	1		17	11		37	21	
8	1		17	11		38	31	
9	1		7	8		39	20	
10	1		15	3		40	22	
11	1		17	2		41	12	
12	1		13	3		42	17	
13	1		5	6		43	12	
14	1		20	5		44	15	
15	1		21		5	45	17	
16	1		22		9	46	13	
17	1		23		10	47	15	
18	1		5		3	48	28	
19	1		7		4	49	13	
20	1		20		4	50	13	
21	1		18		5	51	24	
22	1		13		3	52	26	
23	1		20		2	53	21	
24	1		5		4	54	17	
25	1		20		13	55	19	
9 1/2 1 1/2			9 1/2			8 1/2		
Fine Lam 191			63			91		

10

S. PIKE Sales
(Forest)

John Doe Jan 15, 1914
(Purchaser) (Date)

Species

Material

Cordwood—Mixed Species

DATE SCALED NO. PIECES NO. PIECES NO. PIECES NO. PIECES NO. PIECES

No. Rick Height Length Width Cords

Mar. 15	5	4.5	40	4	5.6
" "	6	4	40	4	5.
" "	7	3.5	32	4	3.5
" "	8	4	50	4	6.25

Remarks on	Page	Item	NO. PIECES	LINEAR FEET	20.35
	94		NO. PIECES	LINEAR FEET	

648—CORD MEASUREMENT.

Compartment _____ Scaler, *John Clark*

Sec. *23*, T. *4 N.*, R. *6 W.*

(Where scaled)

No. Pieces

	NO. PIECES	LINEAR FEET	GRAND TOTALS	RAILROAD TIES	MISCELLANEOUS	MISCELLANEOUS
			<i>Total this page</i>	<i>Cords</i>		<i>20.35</i>
			<i>Brought forward</i>	.		<i>40.50</i>
			<i>Total since last report</i>			<i>60.85</i>
			<i>Reported to</i>			<i>100.15</i>
			<i>Total to</i>			<i>161.00</i>

S. UINTA Sales

(Forest)

J. C. Brown & Co.

Nov. 10, 1913

(Purchaser)

(Date)

Species	Green				
Material	Lodge-Pole Pine				
	8 Ft. Props	10 Ft. Props	12 Ft. Props	14 Ft. Props	16 Ft. Props
DATE SCALED	NO. PIECES	NO. PIECES	NO. PIECES	NO. PIECES	NO. PIECES
Dec. 15, '13	(3) 40	(10) 32	(17) 26	(22) 14	(31) 43
	(4) 66	(11) 44	(18) 38		(32) 57
	(5) 92	(12) 61	(19) 43	(23) 24	(33) 75
Dec. 20, '13	(4) 59	(10) 34	(20) 62	(23) 18	(31) 62
	(6) 214	(11) 156	(19) 79	(22) 42	(32) 186
Dec. 28, '13	(7) 143	(12) 102	(18) 68	(21) 27	(31) 116
	(3) 72	(13) 64	(17) 48	(22) 23	(32) 63

Figures in () indicate serial nos.

Remarks on Page <u>20</u> Item <u>(c)</u>	NO. PIECES	LINEAR FEET
		686
	493	4930
	364	4368
	148	2072
	602	9632

Purchaser Standard Timber Co.

Timber Sale 7/1-19 Wyoming N.F.

Species		Lodgepole-Englemann Spr.-Limb Pine				Culls		
Material		Ties				Culls		
DATE SCALED	No. PIECES	No. PIECES	No. PIECES	No. PIECES	No. PIECES	No. PIECES	No. PIECES	
9/3-24	887	903	919	935		1		
	13	20	23	31				
	88	4	20	6			2	
	32	16	17	17				
	89	5	1	7			2	
	20	17	12	20	2		2	
	90	6	2	8				
	58	13	5	7	3			
	1	7	3	9				
	34	32	14	11				
9/6-24	2	8	4	40				
	29	23	8	26				
	3	9	5	1				
	13	22	38	24		1	1	
	4	10	6	2				
	14	14	23	18				
	5	11	7	3				
	11	10	50	48				
	6	12	8	4				
	13	24	32	30	1			
	7	13	9	5				
	16	33	31	25				
	8	14	30	6				
	17	20	13	26				
	9	15	1	7				
	25	16	17	20	2			
	900	16	2	8				
	28	14	15	10				
	1	17	3	9				
	14	52	20	26	1			
	2	18	4	50				
	15	20	35	38	1			
Remarks on Page Item	No. of PILES		No. of PILES		No. of PILES		No. of PILES	
	352		346		353		373	
(x Left-hand column of figures shows pile No. and right hand column No. of pieces in pile.)								

LOG-SCALING AND GRADING RULES OF THE PUGET SOUND LOG
SCALING AND GRADING BUREAU

DOUGLAS FIR LOGS

No. 1 Logs.

No. 1 logs shall be logs which, in the judgment of the scaler shall be 16 feet in length and up, suitable for the manufacture of lumber in the grade of No. 2 clear, or better, to an amount of not less than 50 per cent of the scaled contents.

No. 2 Logs.

No. 2 logs shall be not less than 12 feet long and having defects which prevent their grading No. 1, but which, in the judgment of the scaler, will be suitable for the manufacture of lumber, principally in the grades of merchantable and better.

No. 3 Logs.

No. 3 logs shall be not less than 12 feet long and having defects which prevent their grading No. 2, but which, in the judgment of the scaler, will be suitable for the manufacture of common lumber.

GRAY FIR

The rules covering the grades of gray fir are the same as No. 2 and No. 3 Douglas fir.

CULL LOGS

Cull or wood logs.—This bureau to recognize a grading to be known as wood logs. Said logs to be scaled for their full contents, including bark.

LOG-SCALING AND GRADING RULES OF THE COLUMBIA RIVER LOG
SCALING AND GRADING BUREAU

DOUGLAS FIR LOGS

No. 1 Logs.

No. 1 logs shall be logs which, in the judgment of the scaler, will be suitable for the manufacturer of lumber in the grades of No. 2 clear or better to an amount of not less than 50 per cent of the scaled contents.

No. 1 logs shall contain not less than six annual rings to the inch in the outer portion of the log equal to one-half of the log content, and No. 1 logs shall be straight grained to the extent of a variation of not more than 2 inches to the lineal foot for a space of 6 lineal feet equidistant from each end of the log.

Rings, rot, or any defect that may be eliminated in the scale are permitted in a No. 1 log, providing their size and location do not prevent the log producing the required amount of No. 2 clear or better lumber.

A No. 1 log may contain a few small knots or well-scattered pitch pockets as permitted in grades of No. 2 clear or better lumber; or may contain a very few grade defects so located that they do not prevent the production of the required amount of clear lumber.

No. 2 Logs.

No 2 logs shall be not less than 12 feet in length, having defects which prevent their grading No. 1, but which, in the judgment of the scaler, will be suitable for the manufacture of lumber principally in the grades of No. 1 common or better.

No. 3 Logs.

No. 3 logs shall be not less than 12 feet in length, having defects which prevent their grading No. 2, but which, in the judgment of the scaler, will be suitable for the manufacture of inferior grades of lumber.

CULL LOGS

Cull logs shall be any logs which do not contain 33 $\frac{1}{2}$ per cent of sound lumber.

WESTERN YELLOW PINE LOG GRADING RULES SUGGESTED BY THE FOREST SERVICE FOR USE IN EASTERN OREGON AND WASHINGTON

Clear logs shall be 22 inches or over in diameter inside the bark at the small end and not less than 10 feet long. They shall be reasonably straight-grained, practically surface clear, and of a character which in the judgment of the scaler are capable of cutting not less than 25 per cent of their scaled contents into lumber of the grades of C select and better.

Shop logs shall be 18 inches or over in diameter inside the bark at the small end, not less than 8 feet long, and which in the judgment of the scaler are capable of cutting not less than 30 per cent of their scaled contents into lumber of the grades of No. 2 shop and better.

Rough logs shall be 6 inches or over in diameter inside the bark at the small end and not less than 8 feet long, having defects which in the judgment of the scaler prevent their classification into either of the two above grades.





3 9015 05843 0607

Forestry

SD
533
U58
1935

U.S. Forest Service
Instructions for
the scaling and
measurement of nat-
ional forest timber.

to J. H. Matthews

OCT 9
1946

OCT 27
1946

S. UINTA Sales

(Forest)

J. C. Brown & Co.

Nov. 10, 1913

(Purchaser)

(Date)

Species	Green				
	Lodge-Pole Pine				
Material	8 Ft. Props	10 Ft. Props	12 Ft. Props	14 Ft. Props	16 Ft. Props
DATE SCALED	NO. PIECES	NO. PIECES	NO. PIECES	NO. PIECES	NO. PIECES
Dec. 15, '13	(3) 40	(10) 32	(17) 26	(22) 14	(31) 43
	(4) 66	(11) 44	(18) 38		(32) 57
	(5) 92	(12) 61	(19) 43	(23) 24	(33) 75
Dec. 20, '13	(4) 59	(10) 34	(20) 62	(23) 18	(31) 62
	(6) 214	(11) 156	(19) 79	(22) 42	(32) 186
Dec. 28 '13	(7) 143	(12) 102	(18) 68	(21) 27	(31) 116
	(3) 72	(13) 64	(17) 48	(22) 23	(32) 63

Figures in () indicate serial nos.

Remarks on Page Item	NO. PIECES	LINEAR FEET
(c)	493	4930
	364	4368
	148	2072
	602	9632

Purchaser Standard Timber Co.

Timber Sale 7/1-19 Wyoming N.F.

Species	Lodgepole-Englemann				Spr.-Limber Pine			
Material	Ties						Culls	
DATE SCALED	No. PIECES	No. PIECES	No. PIECES	No. PIECES	No. PIECES	No. PIECES	No. PIECES	No. PIECES
9/3-24 ^x	887	903	919	935				
	13	20	23	31			1	
	88	4	20	6				2
	32	16	17	17				
	89	5	1	7				2
	20	17	12	20	2			
9/6-24	90	6	2	8				
	58	13	5	7			3	
	1	7	3	9				
	34	52	14	11				
	2	8	4	40				
	29	22	8	26				
	3	9	5	1				1
	13	22	38	24				1
	4	10	6	2				
	14	14	23	19				
	5	11	7	3				
	11	10	50	48				
	6	12	8	4				
	13	24	32	30			1	
	7	13	9	5				
	16	33	31	25				
	8	14	30	6				
	17	20	13	26				
	9	15	1	7				
	25	16	17	20			2	
	900	16	2	8				
	28	14	15	10				
	1	17	3	9				
	14	52	20	24			1	
	2	18	4	30				
	15	20	35	38			1	
Remarks on Page Item	CULLS							
	No. PIECES							
	352	346	353	373			5	6
	(x Left-hand column of figures shows pile No. and right hand column No. of pieces in pile.)							

**LOG-SCALING AND GRADING RULES OF THE PUGET SOUND LOG
SCALING AND GRADING BUREAU****DOUGLAS FIR LOGS****No. 1 Logs.**

No. 1 logs shall be logs which, in the judgment of the scaler shall be 16 feet in length and up, suitable for the manufacture of lumber in the grade of No. 2 clear, or better, to an amount of not less than 50 per cent of the scaled contents.

No. 2 Logs.

No. 2 logs shall be not less than 12 feet long and having defects which prevent their grading No. 1, but which, in the judgment of the scaler, will be suitable for the manufacture of lumber, principally in the grades of merchantable and better.

No. 3 Logs.

No. 3 logs shall be not less than 12 feet long and having defects which prevent their grading No. 2, but which, in the judgment of the scaler, will be suitable for the manufacture of common lumber.

GRAY FIR

The rules covering the grades of gray fir are the same as No. 2 and No. 3 Douglas fir.

CULL LOGS

Cull or wood logs.—This bureau to recognize a grading to be known as wood logs. Said logs to be scaled for their full contents, including bark.

**LOG-SCALING AND GRADING RULES OF THE COLUMBIA RIVER LOG
SCALING AND GRADING BUREAU****DOUGLAS FIR LOGS****No. 1 Logs.**

No. 1 logs shall be logs which, in the judgment of the scaler, will be suitable for the manufacturer of lumber in the grades of No. 2 clear or better to an amount of not less than 50 per cent of the scaled contents.

No. 1 logs shall contain not less than six annual rings to the inch in the outer portion of the log equal to one-half of the log content, and No. 1 logs shall be straight grained to the extent of a variation of not more than 2 inches to the lineal foot for a space of 6 lineal feet equidistant from each end of the log.

Rings, rot, or any defect that may be eliminated in the scale are permitted in a No. 1 log, providing their size and location do not prevent the log producing the required amount of No. 2 clear or better lumber.

A No. 1 log may contain a few small knots or well-scattered pitch pockets as permitted in grades of No. 2 clear or better lumber; or may contain a very few grade defects so located that they do not prevent the production of the required amount of clear lumber.

No. 2 Logs.

No 2 logs shall be not less than 12 feet in length, having defects which prevent their grading No. 1, but which, in the judgment of the scaler, will be suitable for the manufacture of lumber principally in the grades of No. 1 common or better.

No. 3 Logs.

No. 3 logs shall be not less than 12 feet in length, having defects which prevent their grading No. 2, but which, in the judgment of the scaler, will be suitable for the manufacture of inferior grades of lumber.

CULL LOGS

Cull logs shall be any logs which do not contain 33 $\frac{1}{3}$ per cent of sound lumber.

WESTERN YELLOW PINE LOG GRADING RULES SUGGESTED BY THE FOREST SERVICE FOR USE IN EASTERN OREGON AND WASHINGTON

Clear logs shall be 22 inches or over in diameter inside the bark at the small end and not less than 10 feet long. They shall be reasonably straight-grained, practically surface clear, and of a character which in the judgment of the scaler are capable of cutting not less than 25 per cent of their scaled contents into lumber of the grades of C select and better.

Shop logs shall be 18 inches or over in diameter inside the bark at the small end, not less than 8 feet long, and which in the judgment of the scaler are capable of cutting not less than 30 per cent of their scaled contents into lumber of the grades of No. 2 shop and better.

Rough logs shall be 6 inches or over in diameter inside the bark at the small end and not less than 8 feet long, having defects which in the judgment of the scaler prevent their classification into either of the two above grades.



